Theses and Dissertations

Spring 2012

Impacts of WMA additives on rutting resistance and moisture susceptibility

Thomas Glueckert
University of Iowa

Copyright 2012 Thomas Glueckert

This thesis is available at Iowa Research Online: <https://ir.uiowa.edu/etd/2876>

Recommended Citation

Glueckert, Thomas. "Impacts of WMA additives on rutting resistance and moisture susceptibility." MS (Master of Science) thesis, University of Iowa, 2012.
<https://ir.uiowa.edu/etd/2876>. <https://doi.org/10.17077/etd.pv13aqci>

Follow this and additional works at: <https://ir.uiowa.edu/etd>



Part of the [Civil and Environmental Engineering Commons](#)

IMPACTS OF WMA ADDITIVES ON RUTTING RESISTANCE AND MOISTURE
SUSCEPTIBILITY

by
Thomas Glueckert

A thesis submitted in partial fulfillment
of the requirements for the Master of
Science degree in Civil and Environmental Engineering
in the Graduate College of
The University of Iowa

May 2012

Thesis Supervisor: Professor Hosin Lee

Graduate College
The University of Iowa
Iowa City, Iowa

CERTIFICATE OF APPROVAL

MASTER'S THESIS

This is to certify that the Master's thesis of

Thomas Glueckert

has been approved by the Examining Committee
for the thesis requirement for the Master of Science
degree in Civil and Environmental Engineering at the May 2012 graduation.

Thesis Committee: _____
Hosin Lee, Thesis Supervisor

Wilfrid Nixon

Paul Hanley

To PB

ACKNOWLEDGMENTS

The authors would like to thank the Mid-America Transportation Center (MATC) and the Korea Institute of Construction Technology (KICT) for providing financial support. In addition we would like to thank L.L. Pelling, River Products Company, the Engineering Department of Iowa City, Kumho Petrochemicals, the Asphalt Paving Association of Iowa, the Public Policy Center and The University of Iowa.

ABSTRACT

The implementation of warm-mix asphalt (WMA) is becoming more widespread in the United States of America with a growing number of contractors choosing to utilize various WMA technologies. WMA technologies were developed in order to reduce mixing and compaction temperatures of hot mix asphalt (HMA) without affecting the quality of the pavement. Research into the effects of WMA additives suggests that it may be more susceptible to rutting and moisture damage than traditional HMA pavements. The objective of this research is to evaluate the effects of a single WMA additive on resistance to rutting and moisture damage on lab mixed and field mixed pavements. This objective was completed by conducting extensive laboratory experiments to determine and assess the performance of both WMA and HMA mixtures produced using Iowa aggregates. The conclusions of this study are as follow:

- Reduced mixing and compaction temperatures were achieved using the selected additive.
- The selected WMA additive was successfully used and samples were taken during a local resurfacing project.
- Moisture sensitivity of both field mixed WMA and field mixed HMA were comparable although both failed to meet Iowa DOT standards.
- Dry Indirect Tensile Strength values of lab mixed WMA and HMA samples were nearly the same.
- TSR values of lab mixed HMA surpassed those of lab mixed WMA although both failed to meet Iowa DOT standards.

- The aged field mixed HMA successfully passed the Hamburg Wheel Tracker Test and provided the best creep and stripping values compared to all other field mixed specimens.
- Lab mixed HMA using a PG 64-22 binder performed the best compared to all other lab mixed specimens although none of the lab mixed specimens successfully passed the Hamburg Wheel Tracker Test.

TABLE OF CONTENTS

LIST OF TABLES	vi
LIST OF FIGURES	xiii
LIST OF EQUATIONS	xi
CHAPTER	
1. INTRODUCTION	1
1.1 Objective.....	2
2. LITERATURE REVIEW	4
2.1 Warm Mix Asphalt Technologies	4
2.1.1 Organic Additives.....	4
2.1.2 Chemical Additives	5
2.1.3 Zeolite Additives	5
2.1.4 Foaming Equipment	5
2.2 The Selected Additive Under Study.....	6
2.3 Hamburg Wheel Tracking Test.....	6
2.4 NCHRP WMA Mixture Design Studies.....	9
2.4.1 Volumetric Properties	9
2.4.2 Binder Grade Selection.....	9
2.4.3 Short-Term Oven Conditioning	9
2.4.4 Coating, Workability, and Compactibility.....	10
2.5 WMA Performance Testing Studies	10
2.5.1 Performance Aging.....	10
2.5.2 Moisture Sensitivity.....	10
2.5.3 Rutting Resistance	10
2.5.4 Performance Evaluation.....	11
3. LAB MIXTURE DESIGN AND TESTING.....	14
3.1 HMA Lab Mixture Design.....	14
3.1.1 PG 58-28 Binder.....	14
3.1.2 PG 64-22 Binder.....	15
3.2 Modified Lottman Test Results.....	15
3.3 Hamburg Wheel Tracking Test Results	17
3.3.1 Lab Mixed PG 58-28 HMA	17
3.3.2 Lab Mixed PG 58-28 WMA	18
3.3.3 Lab Mixed PG 64-22 HMA	19
3.3.4 Lab Mixed PG 64-22 WMA	19
3.3.5 Summary Of Lab Mixed Hamburg Results	20
4. CONSTRUCTION OF A PAVEMENT USING THE SELECTED ADDITIVE IN IOWA.....	50
4.1 Field Mixture Design.....	50

4.2	Project Sites	51
4.2.1	WMA Project On Capitol Street	51
4.2.2	HMA Project On Miami Drive	52
4.2.3	Summary Of Project Sites.....	53
4.3	Modified Lottman Test Results.....	53
4.4	Hamburg Wheel Tracking Test Results	54
4.4.1	Field Mixed HMA	55
4.4.2	Field Mixed WMA	55
4.4.3	Aged Field Mixed HMA.....	56
4.4.4	Aged Field Mixed WMA.....	56
4.4.5	Summary Of Field Mixed Hamburg Results	57
5.	COMPILATION AND COMPARISON OF DATA.....	88
5.1	Modified Lottman Test Data.....	88
5.2	Hamburg Wheel Tracking Test Data.....	89
5.2.1	Lab Mixed Data.....	89
5.2.2	Field Mixed Data.....	91
6.	SUMMARY AND CONCLUSIONS	99
	APPENDIX A. LABORATORY TESTING PROCEDURES.....	102
	APPENDIX B. DATA OF ALL EXPERIMENTS	120
	APPENDIX C. GSB INFO FROM RIVER PRODUCTS COMPANY	135
	APPENDIX D. FIELD DATA FROM L.L. PELLING	137
	REFERENCES.....	142

LIST OF TABLES

Table

3.1	Aggregate information	22
3.2	Volumetric data used to determine the OBC using PG 58-28 binder.....	24
3.3	Temperatures during mixture design using PG 58-28	27
3.4	Volumetric data used to determine the OBC with PG 64-22 binder.	28
3.5	Temperatures during mixture design using PG 64-22	31
3.6	Conditioning requirement for performance testing	31
3.7	Volumetric information of lab mixed specimens used for Modified Lottman Testing.....	32
3.8	Indirect tensile strength of lab mixed HMA specimen	33
3.9	Indirect tensile strength of lab mixed WMA specimen	33
3.10	Lab mixed PG 58-28 HMA Hamburg test data.....	37
3.11	Lab mixed PG 58-28 WMA Hamburg test data.....	40
3.12	Lab mixed PG 64-22 HMA Hamburg test data.....	43
3.13	Lab mixed PG 64-22 WMA Hamburg test data.....	46
3.14	Summary of data collected during lab mixed Hamburg Wheel Tracking Tests	49
4.1	Aggregate information	58
4.2	Asphalt mixture properties	62
4.3	Field HMA and WMA temperatures	65
4.4	Field core data from Capitol Street.....	67
4.5	Field core data from Miami Drive	69
4.6	Direct comparison of job sites	70
4.7	Volumetric information of field mixed specimens used for Modified Lottman Testing.....	71
4.8	Indirect tensile strength of field mixed HMA specimens.	72
4.9	Indirect tensile strength of field mixed WMA specimens	72

4.10	Field mixed HMA Hamburg test data.....	75
4.11	Field mixed WMA Hamburg test data.....	78
4.12	Aged field mixed HMA Hamburg test data	81
4.13	Aged field mixed WMA Hamburg test data	84
4.14	Summary of data collected during field mixed Hamburg Wheel Tracking Tests.....	87
5.1	Comparison of Modified Lottman test results.....	93
5.2	Comparison of passes to failure of lab mixed specimens	95
5.3	Comparison of creep slopes of lab mixed specimens	95
5.4	Comparison of stripping slopes of lab mixed specimens.....	96
5.5	Comparison of stripping inflection points of lab mixed specimens	96
5.6	Comparison of passes to failure of field mixed specimens.....	97
5.7	Comparison of creep slopes of field mixed specimens.....	97
5.8	Comparison of stripping slopes of field mixed specimens	98
5.9	Comparison of stripping inflection points of field mixed specimens.....	98
B1	Gmm data and results from Rice Specific Gravity Tests.....	121
B2	Gmb data and results of HMA using PG 58-28 binder.....	122
B3	Gmb data and results of HMA using PG 64-22 binder.....	123
B4	TSR volumetric results of lab mixed HMA using PG 58-28.....	123
B5	TSR volumetric results of lab mixed WMA using PG 58-28 modified with 1.0% additive.....	124
B6	TSR volumetric results of field mixed HMA.....	125
B7	Hamburg volumetric results of lab mixed HMA using PG 58-28.....	126
B8	Hamburg volumetric results of lab mixed WMA using PG 58-28 modified with 1.5% additive	126
B9	Hamburg volumetric results of lab mixed HMA using PG 64-22.....	127
B10	TSR volumetric results of lab mixed WMA using PG 64-22 modified with 1.0% additive.....	128
B11	Hamburg volumetric results of field mixed HMA	129

B12	Hamburg volumetric results of field mixed WMA	129
B13	Hamburg volumetric results of aged field mixed HMA	130
B14	Hamburg volumetric results of aged field mixed WMA	131
B15	Gmbs for lab mixed Hamburg HMA specimens using PG 58-28 binder	132
B16	Gmbs for lab mixed Hamburg WMA specimens using PG 58-28 binder	132
B17	Gmbs for lab mixed Hamburg HMA specimens using PG 64-22 binder	132
B18	Gmbs for lab mixed Hamburg WMA specimens using PG 64-22 binder	133
B19	Gmbs for field mixed Hamburg HMA specimens.....	133
B20	Gmbs for field mixed Hamburg WMA specimens.....	133
B21	Gmbs for aged field mixed Hamburg HMA specimens	134
B22	Gmbs for aged field mixed Hamburg WMA specimens	134

LIST OF FIGURES

Figure

2.1	Temperature-Viscosity behavior of asphalt binder	11
2.2	Effect if crystal controller found in the selected additive	12
2.3	Effects of the adhesion promoter found in the selected additive	12
2.4	The selected WMA additive.....	13
2.5	Hamburg Wheel Tracking Device	13
3.1	Lab mixed limestone gradation with tolerances	23
3.2	Percent air voids VS asphalt content (PG 58-28).....	25
3.3	Percent Gmm @ N-initial VS asphalt content (PG 58-28).....	25
3.4	Percent VMA VS asphalt content (PG 58-28)	26
3.5	Percent VFA VS asphalt content (PG 58-28).....	26
3.6	Percent DP VS asphalt content (PG 58-28)	27
3.7	Percent air voids VS asphalt content (PG 64-22).....	28
3.8	Percent Gmm @ N-initial VS asphalt content (PG 64-22).....	29
3.9	Percent VMA VS asphalt content (PG 64-22)	29
3.10	Percent VFA VS asphalt content (PG 64-22).....	30
3.11	Percent DP VS asphalt content (PG 64-22)	30
3.12	Indirect tensile strength and TSR of lab mixed HMA and WMA specimens using PG 58-28.....	34
3.13	Stripping effects on lab mixed HMA specimens.....	35
3.14	Stripping effects on lab mixed WMA specimens.....	35
3.15	Dimensions of specimens and molds used in the Hamburg Wheel Tracking Test.....	36
3.16	Lab mixed PG 58-28 HMA rut depth VS wheel passes	38
3.17	Lab mixed PG 58-28 HMA rut profile	38
3.18	Test LH1 (PG 58-28) specimens before testing (top).....	39

3.19	Test LH1 (PG 58-28) specimens before testing (side)	39
3.20	Test LH1 (PG 58-28) specimens after testing (top).....	39
3.21	Test LH1 (PG 58-28) specimens after testing (side)	40
3.22	Lab mixed PG 58-28 WMA rut depth VS wheel passes	41
3.23	Lab mixed PG 58-28 WMA rut profile.....	41
3.24	Test LW2 (PG 58-28) specimens before testing (top).....	42
3.25	Test LW2 (PG 58-28) specimens before testing (side).....	42
3.26	Test LW2 (PG 58-28) specimens after testing (top).....	42
3.27	Test LW2 (PG 58-28) specimens after testing (side)	43
3.28	Lab mixed PG 64-22 HMA rut depth VS wheel passes	44
3.29	Lab mixed PG 64-22 HMA rut profile	44
3.30	Test LH1 (PG 64-22) specimens before testing (top).....	45
3.31	Test LH1 (PG 64-22) specimens before testing (side)	45
3.32	Test LH1 (PG 64-22) specimens after testing (top).....	45
3.33	Test LH1 (PG 64-22) specimens after testing (side)	46
3.34	Lab mixed PG 64-22 WMA rut depth VS wheel passes	47
3.35	Lab mixed PG 64-22 WMA rut profile.....	47
3.36	Test LW3 (PG 64-22) specimens before testing (top).....	48
3.37	Test LW3 (PG 64-22) specimens before testing (side).....	48
3.38	Test LW3 (PG 64-22) specimens after testing (top).....	48
3.39	Test LW3 (PG 64-22) specimens after testing (side)	49
4.1	Individual aggregate gradations	59
4.2	Combined aggregate gradation with tolerances	60
4.3	Percent air voids VS asphalt content	62
4.4	Percent Gmm @ N-initial VS asphalt content	62
4.5	Percent VMA VS asphalt content.....	63
4.6	Percent VFA VS asphalt content	63

4.7	Percent DP VS asphalt content.....	64
4.8	Pavement projects in Iowa City during the 2012 fiscal year	65
4.9	Capitol Street job site.....	66
4.10	Miami Drive job site	68
4.11	Indirect tensile strength and TSR of field mixed HMA and WMA specimens	73
4.12	Stripping effects of field mixed HMA specimens	74
4.13	Stripping effects on field mixed WMA specimens	74
4.14	Field mixed HMA rut depth VS wheel passes	76
4.15	Field mixed HMA rut profile	76
4.16	Test FH2 specimens before testing (top)	77
4.17	Test FH2 specimens before testing (side)	77
4.18	Test FH2 specimens after testing (top)	77
4.19	Test FH2 specimens after testing (side).....	78
4.20	Field mixed WMA rut depth VS wheel passes	79
4.21	Field mixed WMA rut profile	79
4.22	Test FW2 specimens before testing (top)	80
4.23	Test FW2 specimens before testing (side)	80
4.24	Test FW2 specimens after testing (top)	80
4.25	Test FW2 specimens after testing (side).....	81
4.26	Aged field mixed HMA rut depth VS wheel passes.....	82
4.27	Aged field mixed HMA rut profile	82
4.28	Test FHA1 specimens before testing (top).....	83
4.29	Test FHA1 specimens before testing (side)	83
4.30	Test FHA1 specimens after testing (top)	83
4.31	Test FHA1 specimens after testing (side)	84
4.32	Aged field mixed WMA rut depth VS wheel passes.....	85
4.33	Aged field mixed WMA rut profile	85

4.34	FWA3 specimens before testing (top)	86
4.35	FWA3 specimens before testing (side)	86
4.36	Test FWA3 specimens after testing (top)	86
4.37	Test FWA3 specimens after testing (side)	87
5.1	Stripping on lab mixed HMA specimen	94
5.2	Stripping on lab mixed WMA specimen.....	94
A1	Rice specific gravity test equipment	104
A2	Weight of the sample in dry condition.....	105
A3	Weight of the sample in water.....	105
A4	Surface saturation of the sample.....	106
A5	Dry and wet set of specimens for moisture sensitivity test.....	107
A6	Specimen after compaction	108
A7	Reconditioning of the dry subset	109
A8	Vacuum of a specimen.....	110
A9	Freezing of the wet specimens at -18°C for 16 hours	111
A10	Specimens inside the water bath at 60°C for 24 hours	112
A11	Indirect Tensile Strength of a specimen.....	113
A12	Concrete saw used to cut specimens.....	116
A13	70.0 mm core marked and loaded into the core grip	117
A14	Marked core prepared to have 7.5 mm shaved off	118
A15	Cores loaded into the Hamburg Wheel Tracker	118
B1	Visualization of lab mixed TSR volumetric data	124
B2	Visualization of field mixed TSR volumetric data.....	125
B3	Visualization of lab mixed PG 58-28 Hamburg volumetric data.....	127
B4	Visualization of lab mixed PG 64-22 Hamburg volumetric data.....	128
B5	Visualization of field mixed Hamburg volumetric data	130
B6	Visualization of aged field mixed Hamburg volumetric data	131

C1	Gsb calculation from River Products Company	136
D1	Aggregate gradation.....	138
D2	Mixture design completed by L.L. Pelling.....	139
D3	Core info from Capitol Street gathered by L.L. Pelling	140
D4	Core info from Miami Drive gathered by L.L. Pelling.....	141

LIST OF EQUATIONS

Equation

A1	Specific Gravity (G _{mm}).....	104
A2	Bulk specific gravity (G _{mb}).....	106
A3	Air voids present in samples	106
A4	Tensile Strength.....	113
A5	Tensile Strength Ratio.....	114
A6	Stripping Inflection Point.....	119

CHAPTER 1

INTRODUCTION

Hot mix asphalt (HMA) is a term used to describe many different mixtures of aggregate and asphalt binder that are mixed and compacted at high temperatures ranging from 135⁰C and 176⁰C (275⁰F and 350⁰F). The proportions of the aggregate and asphalt binder needed for the mixture are determined through the Superpave mixture design procedure, which is the mixture design method that was used throughout this study. The goal of the mixture design procedures is to ensure that the HMA mixture produced will meet specific performance criteria such as percent air voids and percent of voids filled with asphalt. Along with these criteria, it is also important to ensure that the asphalt binder fully coats the aggregate and that the mixture will be workable and compactable. The asphalt binder and aggregate need to be heated to high temperatures so that the aggregate is thoroughly dried and the viscosity of the asphalt binder is low enough to ensure the proper level of coating and workability is reached.

New technologies are constantly emerging that allow the pavement industry to produce asphalt mixtures at temperatures 15⁰C to 50⁰C (30⁰F to 100⁰F) lower than what is typically needed for HMA. These technologies are typically referred to as Warm Mix Asphalt (WMA). The goal of using WMA is to produce asphalt mixtures with similar physical properties as HMA using reduced temperatures. Reducing asphalt production temperatures has several benefits including reduced emissions, fumes, odors, and providing a cooler work environment. All of these benefits will occur while using less energy to produce the asphalt mixture and aging the asphalt binder less which can potentially improve the pavement performance. However, the use of WMA technology

could result in less hardening of the asphalt binder which may increase the rutting potential of the asphalt mixture.

1.1 Objective

The three main objectives of this project are to: 1) perform a mix design and Hamburg Wheel Tracking test of additive modified mixtures, 2) construct a pavement using the WMA additive in Iowa and 3) compare the physical and volumetric of the lab and field mixed pavements. This project also addresses some relevant questions about the implementation and testing of WMA additives as follows:

- What are the mix design criteria of WMA mixtures using Iowa aggregates?
- How are Hamburg test results impacted by different amounts of additives?
- How do HMA and WMA field mixtures compare in TSR and Hamburg tests?
- How do TSR test results of field mixtures compare to those of lab mixtures?
- How do Hamburg test results of field mixtures compare to those of lab mixtures?

First, a thorough mix design was performed for the selected additive modified mixture using Iowa aggregates. Mix designs were performed using two different PG binders and additive amounts. Upon completion of the mix design the mixtures were tested for their indirect tensile strengths, rutting resistance and moisture susceptibility. The rutting resistance and moisture susceptibility were determined using the Hamburg Wheel Tracking Test and the Modified Lottman Test. Second, a pavement was constructed using the additive in Iowa. The contractor performed a mix design and built a pavement using and asphalt modified with the additive. Asphalt mixtures were collected from the job site to determine Indirect Tensile Strength, rutting resistance and

moisture susceptibility. A half of the field samples were tested immediately and the other half were tested after a period of seven months to see how short term aging would affect the mixture performance.

CHAPTER 2

LITERATURE REVIEW

WMA technologies were first introduced at the Bitumen Forum of Germany in 1997 as one way to reduce greenhouse gas emissions during the production of asphalt (1). WMA is described as "...a group of technologies which allow a reduction in the temperatures at which asphalt mixtures are produced and place." (2). The main goal of WMA additives is to reduce the viscosity of the asphalt binder at a temperature lower than those typically associated with HMA. Figure 2.1 shows the relationship between the viscosity and temperature of a typical asphalt binder compared to one that has been modified with an organic additive. As can be observed from the Figure 2.1, at temperatures higher than 100°C, the asphalt binder that has been modified with the additive has a lower viscosity than the unmodified asphalt binder.

2.1 Warm Mix Asphalt Technologies

There are many different products and processes that are used to achieve this reduction in temperature but the technologies can generally be grouped into four main categories.

2.1.1 Organic Additives

Organic additives are waxes that are used to reduce the viscosity of asphalt binder at lower temperatures. Sasobit®, produced by Sasol Wax Americas, Inc. is an example of a wax based organic additive and is the most often used organic additive in the United States (3).

2.1.2 Chemical Additives

Chemical additives, which are also known as surfactants, are an emerging group of additives for WMA. Surfactants help the asphalt binder coat the aggregate at a lower temperature. Evotherm™ Emulsion Technology (ET) which is produced by MeadWestvaco Asphalt Innovations is an example of a chemical additive. The process consists of the additive being blended with asphalt that is mixed with the aggregates to produce asphalt mixtures with a 55⁰C (100⁰F) reduction in production temperature. Evotherm™ requires no plant modification and the majority of the water in the emulsion flashes off when the emulsion is mixed with hot aggregates (4).

2.1.3 Zeolite Additives

Small amounts of water are introduced into the heated asphalt binder to form a controlled foaming effect that results in a small increase in binder volume and a reduction in viscosity. Water-bearing additives such as synthetic zeolites are used to enhance aggregate coating by asphalt at lower temperatures. Zeolites have porous structures that include approximately 20% water. When heated to a specified temperature, the water is released and foamed asphalt is produced (5). Advera®, produced by the PQ Corporation, is an example of a water-bearing additive. Advera® is a hydrated zeolite powder that can be added to reduce the production temperature of asphalt mixtures by 10⁰C to 21⁰C (50⁰F to 70⁰F). Advera® can be added to asphalt mixtures without any mixture design changes (6).

2.1.4 Foaming Equipment

Foamed asphalt is produced by adding a small amount of water to the heated asphalt through the means of a nozzle or damped aggregate. Introducing the moisture into a

stream of hot asphalt causes spontaneous foaming of the asphalt which increases the surface area of the asphalt while lowering its viscosity. Foaming technology is believed to be the most cost effective from the WMA technologies since it does not require any costly additives to be added to the mixture (7).

2.2 The Selected Additive Under Study

The selected WMA additive that was used over the course of this study is a wax based organic additive. The selected additive is uniquely different from others because it includes a crystal controller and an adhesion promoter. A problem that occurs with wax based additives is the fact that they tend to produce a weak crystal structure in asphalt mixtures. This leads to a weakness in low temperature cracking. The crystal controller, shown in Figure 2.2, was added to the selected WMA additive in order to produce a dense crystal structure in asphalt mixtures therefore increasing the low temperature cracking resistance. A secondary problem that occurs in WMA is that it can be highly sensitive to moisture damage. A typical solution to this problem is to add an anti-stripping agent to the mixture such as lime. The selected WMA additive that was in this study has an adhesion promoter that should attract asphalt to the aggregate as shown in Figure 2.3. Figure 2.4 shows the WMA additive selected for this study, which was added to the asphalt binder at a temperature above 125°C, the activation temperature of the additive.

2.3 Hamburg Wheel Tracking Test

The Hamburg Wheel Tracking Device, as shown in Figure 2.3, was developed in the 1970's in the City of Hamburg, Germany and is used to determine the susceptibilities of both rutting and moisture of an asphalt mix based on pass fail criteria (8). The test

performed by the equipment runs a solid steel wheel across two 150 mm diameter asphalt cores or a loose mix that is held in place by plaster of Paris. The steel wheel has a diameter of 203.5 mm with a width of 47.0 mm and a constant load of 685 N. The tests are run in a water bath that is heated to 50° C and the samples are conditioned 30 minutes at this temperature before the test starts. The test is completed when the wheel has passed over the specimens 20,000 times over 6.5 hours or when the rut depth exceeds 20 mm. The maximum allowable rut depth recommended by the Colorado Department of Transportation (CDOT) is 4 mm at 10,000 wheel passes and 10 mm at 20,000 wheel passes (9). The Texas Department of Transportation (TxDOT) recommends a different set of criteria. They recommend that for mixtures using a PG 64-xx binder be able to reach 10,000 passes without reaching a rut depth of 12.5 mm (10). They came to this conclusion by examining over 3,700 Hamburg test results. While examining these results they saw an decrease in rut depth while using an anti-stripping agent. The Hamburg Wheel Tracking Device measures rut depth throughout the test and reports four properties outside the pass fail criteria. The four properties are post-compaction consolidation, creep slope, stripping inflection point (SIP), and stripping slope. The post-compaction consolidation occurs at 1,000 wheel passes. This is assumed to be the densification of the mixture and does not necessarily show rutting. The creep slope is used to measure the rutting susceptibility of the mixture. This slope measures the permanent deformation caused by the wheel passes. Creep slopes can be used to evaluate resistance to rutting instead of rut depths due to the fact that the damage caused by moisture begins to occur at can vary. The stripping inflection point and the stripping slope are used to measure damages to the specimens by moisture with the stripping inflection point being the point

where moisture damage begins to occur. CDOT suggests that a stripping inflection point that occurs before 10,000 passes indicates moisture susceptibility. The inverse slopes are reported so they can be reported as in terms of wheel passes. Higher slopes and a higher inflection point indicate less damage (11).

Izzo et al. (12) presented information comparing the results of rectangular and cylindrical specimens tested with the Hamburg Wheel Tracker. When comparing the standard deviation of the data for the creep slope, stripping slope and SIP, it was shown that using cylindrical specimens results in a smaller deviation. The research performed also examined the impacts of different testing temperatures and additives. It was observed that using a testing temperature of 40°C resulted in a greater number of passes to failure as well as a higher SIP when compared to test results at 50°C. The use of an anti-stripping additive increased the number of passes to failure and using hydrated lime increased them even further. The use of hydrated lime in the asphalt mixture resulted in samples that did not experience stripping damage caused by moisture. Hall et al. (14) compared Hamburg Wheel Tracking Test results using a field produced mixture. They compared the results of different specimen types, field cut rectangular, field cut cylindrical, and lab produced cylindrical. They found that the field cut rectangular and cylindrical specimens had similar results in terms of rutting resistance. This led them believe that when specimens are cut directly from the field, it is not important how the specimen is cut. When comparing specimens cut from the field and specimens produced using a gyratory compactor it was noticed that the specimens produced using the gyratory compactor showed significantly lower rut depths. This can possibly be attributed to the compacted specimens having lower air voids than the field cut specimens. They also

determined that sawing a flat face on cylindrical specimens did not have a significant impact on rutting resistance. Yildirim et al. (13) performed Hamburg Wheel Tracking Tests on plant-produced mixtures while monitoring field data in an effort to correlate the Hamburg Wheel Tracking Test results to the field data. Over a period of four years the ESALs and rutting were recorded for each of the four paved lanes. The ESALs per mm of rut depth were compared to the wheel passes per mm of rut depth to determine the equivalent ESALs per Wheel Pass. It was concluded that rut depth should be analyzed at multiple wheel passes to better understand the creep slope because post compaction depth can greatly influence the creep slope.

2.4 NCHRP WMA Mixture Design Studies

NCHRP Project 09-43 (5) was performed to develop mix design procedures for WMA mixtures. Their findings are briefly described below:

2.4.1 Volumetric Properties:

Volumetric properties for HMA mixtures with 1.0 percent binder absorption are essentially the same as those obtained for WMA mixtures. This conclusion supports the current practice of substituting a WMA process into an approved HMA mixture design.

2.4.2 Binder Grade Selection

The draft appendix to AASHTO R 35 recommends that the same grade of binder be used in both WMA and HMA mixtures for the same project location

2.4.3 Short-Term Oven Conditioning

To simulate the absorption and aging of the binder that occurs during construction, it is appropriate to short-term age WMA mixtures for 2 hours at the WMA

compaction temperature. The same short-term oven conditioning is used for both volumetric and performance properties.

2.4.4 Coating, Workability, and Compactibility

The change in the number of gyrations to 92 percent relative density when the compaction temperature is decreased by 30⁰C (54⁰F) should be less than 25 percent. If it is greater than 25 percent, the WMA mixture may be more temperature sensitive. The determined number of gyrations to 92 percent relative density has to be less than 125 percent of the value at the recommended compaction temperature.

2.5 WMA Performance Testing Studies

Report 691 (15) describes the performance testing procedures for WMA mixtures.

2.5.1 Performance Aging

For performance testing, simply aging the WMA mixture for four hours similar to the HMA mixtures did not age the binder enough. Specimens need to first be aged for 16 hours at 60⁰C (140⁰F) for 16 hours and then aged for another two hours at compaction temperature. This aging process will result in similar aging for both HMA and WMA mixtures.

2.5.2 Moisture Sensitivity

The draft appendix to AASHTO R 35 includes evaluation of moisture sensitivity using AASHTO T 283. WMA mixtures are more prone to moisture damage than HMA mixtures designed using the same aggregates and binder when measured using AASHTO T 283.

2.5.3 Rutting Resistance

The draft appendix to AASHTO R 35 includes an evaluation of rutting resistance using the flow number test. When the advised short-term conditioning of 2 hours at compaction temperature is used, the asphalt binder does not experience an ample amount of aging and therefore has a lower flow number than similar HMA mixtures. The current short-term aging criteria of HMA mixtures of 4 hours at compaction 135⁰C (275⁰F) cannot be used for WMA mixtures. This results in a reduction in the recommended criteria of evaluating rutting resistance using the flow number test for WMA mixtures.

2.5.4 Performance Evaluation

NCHRP Project 09-43 showed that when using the same aggregates and binder, WMA mixtures designed in accordance to the draft appendix to AASHTO R 35 will have similar properties and volumetrics as HMA mixtures. They will however, have less stiffness than HMA mixtures because of short-term conditioning.

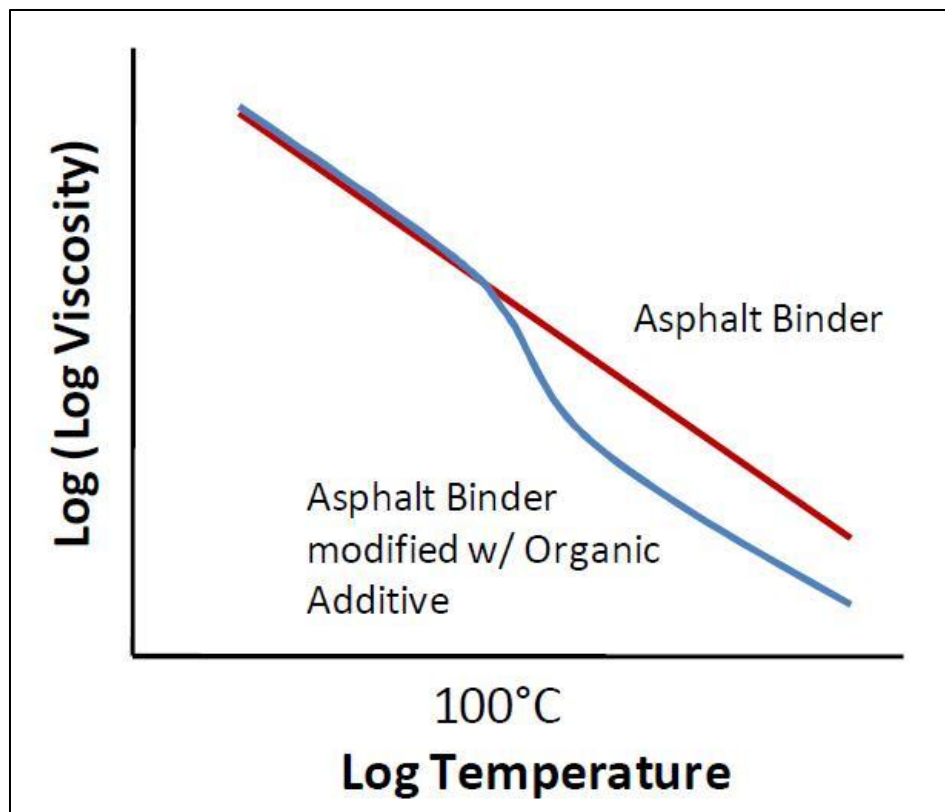

Figure 2.1: Temperature-Viscosity behavior of asphalt binder

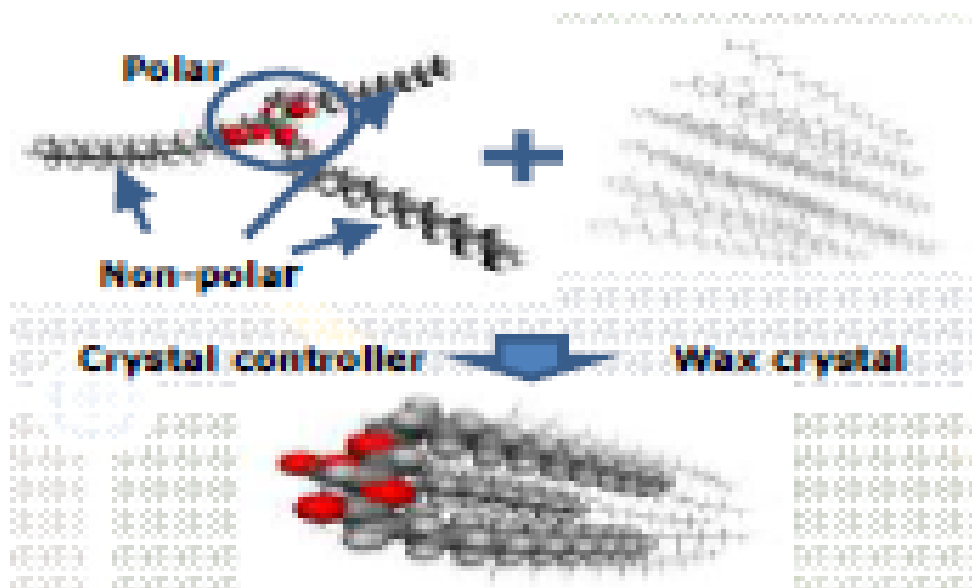

Figure 2.2: Effects of the crystal controller found in the selected additive

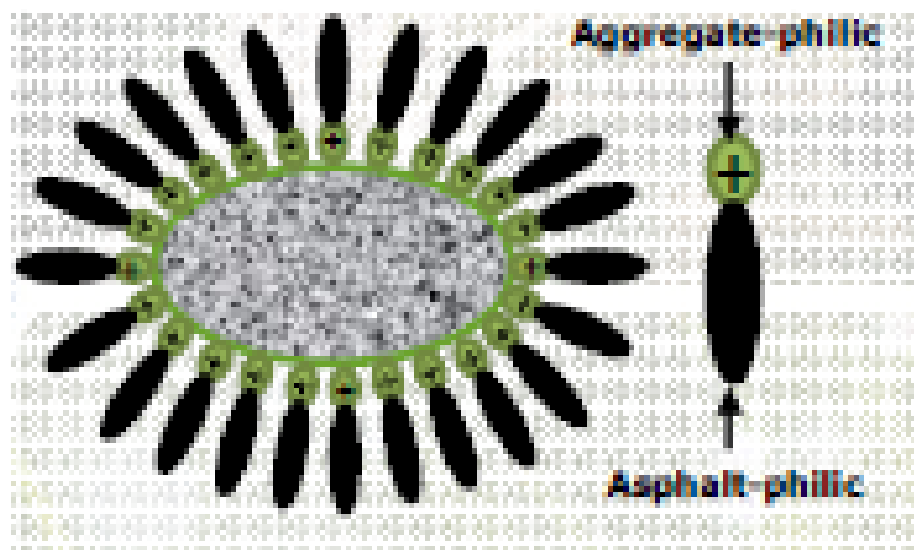

Figure 2.3: Effects of the adhesion promoter found in the selected additive



Figure 2.4: The Selected WMA Additive



Figure 2.5: Hamburg Wheel Tracker Device

CHAPTER 3

LAB MIXTURE DESIGN AND TESTING

Laboratory mixed HMA and WMA specimens were produced in accordance with AASHTO procedures modified with NCHRP Project 09-43 findings and tested to determine the effects of the selected WMA additive on rutting resistance and moisture sensitivity in a controlled environment.

3.1 HMA Lab Mixture Design

Two separate 1-million ESAL mixture designs were completed using two different binders, a PG 58-28 and a PG 64-22. Design gyrations were set at 76 with the initial gyrations set at 7 and maximum gyrations set at 117. Limestone aggregates with a ½” nominal maximum size from River Products Quarry in Coralville, Iowa were used. Information about the aggregate and the gradation can be found in Table 3.1 and Figure 3.1.

3.1.1 PG 58-28 Binder

A mixture design process on the selected gradation was performed to determine the optimum binder content using a PG 58-28 binder. The asphalt binder selected has a specific gravity of 1.036 at 25°C. Compacted specimens using the PG 58-28 binder at 5.20, 5.65, and 6.10 percent binder content were produced. Using the data from the compacted specimens it was estimated that a binder content of 5.00 percent would produce $4.0 \pm 0.5\%$ air voids (Specimens produced at this binder content produced air voids of 3.77% which is within the accepted limits). The mixture data can be found from Table 3.2 with graphical representations in Figure 3.2, 3.3, 3.4, 3.5, and 3.6. The percent

asphalt absorption of all the compacted cores was 0.88%, which remained constant throughout all asphalt contents because the effective specific gravity of the aggregate was constant. Because the asphalt absorption is less than 1.00% a separate WMA mixture design was not needed. The only difference between the WMA mixture and the HMA mixture was the additive and the temperatures used during mixing and compaction. The PG 58-28 was modified with the selected additive at a dosage rate of 1.5% and the temperatures were lowered. The lowered WMA temperatures as well as the HMA temperatures can be seen from Table 3.3.

3.1.2 PG 64-22 Binder

A second mixture design was completed using a PG 64-22 binder. The PG 64-22 binder has a specific gravity of 1.043 at 25°C. Specimens at 5.00%, 5.50% and 6.00% binder content were produced. Using data from the compacted specimens it was estimated that a binder content of 5.00% would produce $4.0 \pm 0.5\%$ air voids (Specimens produced at this binder content produced air voids at 4.27% which is within the accepted limits). The mixture data can be found in Table 3.4 with graphical representations in Figure 3.7, 3.8, 3.9, 3.10 and 3.11. The percent asphalt absorption of all the binder contents was 0.58%. Just like the mixture design using PG 58-28, the only difference between the HMA and WMA mixture designs were the additive amounts and the temperatures used during mixing and compaction. The PG 64-22 binder was modified with the additive at a dosage rate of 1.0%. The lowered WMA temperatures as well as the HMA temperatures can be seen from Table 3.5.

3.2 Modified Lottman Test Results

The Modified Lottman Test was performed on both HMA and WMA specimens with PG 58-28 binder. In accordance with AASHTO T-283, the WMA specimens were heated at 60°C for 16 hours followed by 2 hours at the compaction temperature of 115°C. The conditioning times and temperatures for both mixtures are summarized in Table 3.6. The specimens were divided into two groups after compaction, a conditioned and an unconditioned group. The conditioned group was put through a single freeze-thaw cycle while the unconditioned group was kept at a constant room temperature. First, the specimens were subjected to a vacuum while submerged in water. When the specimens reached between 70 and 80 percent saturation they were wrapped in plastic and inserted into a plastic zip-lock bag. Along with the specimens, 10 mL of water was placed into the bag. The freeze-thaw cycle consists of a 16 hour freeze cycle at -18°C and a 24 hour thaw cycle at 60°C. After the thaw cycle the conditioned specimens were subjected to a 2 hour water bath at 25°C. After the 2 hour water bath, both the conditioned and unconditioned specimens were tested for the Indirect Tensile Strength. All of the cores produced for the Modified Lottman Test had air voids between 6.5-7.5 percent. The data for the cores is summarized in the Table 3.7, which shows the volumetric data of HMA and WMA specimens (The L in the specimen ID stands for lab mixed while the H and W stand for HMA and WMA respectively).

As can be seen from Table 3-5, the cores were divided into the unconditioned and conditioned group based on air void content. The average air void for the HMA conditioned specimens was 6.88% whereas 7.21% for the unconditioned specimens.

Similarly for the WMA specimens, the conditioned specimens had an average air void of 7.16% whereas 7.01% for the unconditioned specimens.

Indirect tensile strength test result and Tensile Strength Ratio (TSR) are summarized in Tables 3.8 and 3.9. The average TSR value for HMA specimens is 54.66% whereas the TSR value for WMA specimens is 27.55%. Shown below in Figure 3.12 is a visualization of the above data. These values are significantly lower than the Superpave criterion of 80% and they are plotted in Figure 3.12.

To examine the effects of stripping between asphalt and aggregates the conditioned specimens are broken into halves for a visual observation. As shown in Figure 3.13 and 3.14, respectively, both HMA and WMA specimens experienced a high amount of stripping. Both the HMA and the WMA failed to meet the criteria for passing the Modified Lottman Test. It is recommended that an anti-stripping agent such as lime be added to the mixture for further testing.

3.3 Hamburg Wheel Tracking Test Results

Hamburg Wheel Tracking Tests were performed on HMA and WMA specimens using both selected binders and additive amounts. The specimens had a target air void content of 7.00% with a range of 6.50-7.50%. Specimens were compacted to between 68 and 70 mm and then cut down to 60 mm to fit the for the Hamburg Wheel Tracker. The specimens also had 7.5 mm of material removed from one side so that they fit together in the specimen tray. Figure 3.15 shows the dimensions of the specimen molds and the specimens.

3.3.1 Lab Mixed PG 58-28 HMA

The test results and general information for the lab mixed HMA specimens using PG 58-28 binder are summarized in Table 3.10. As can be seen from the table, the average air void of the lab mixed HMA specimens was 6.62%. The average number of passes it took until a 10 mm rut depth was 5,050. The average number passes it took until a 20 mm rut depth was 10,273. The average creep slope of the three specimens is -0.0008 with an average stripping slope of -0.002. The average stripping inflection point of the three specimens is 1,639. The rut depths versus the wheel passes for the failed point in the three specimens are plotted in Figure 3.16 and the cross-sectional profiles of the three specimens at the failure point in Figure 3.17. Pictures of lab mixed HMA cores before and after testing can be seen from Figures 3.18, 3.19, 3.20 and 3.20. As can be seen from Figure 3.16, there are multiple spikes in the rut depth data, which might have been caused by pieces of aggregate and asphalt mix breaking off and affecting the height measurement. The stripping slope remains the same when these points out were removed.

3.3.2 Lab Mixed PG 58-28 WMA

The test results and general information for the lab mixed WMA specimens using PG 58-28 binder modified with 1.5% additive by asphalt content are summarized in Table 3.11. As can be seen from the table, the average air void of the lab mixed WMA specimens was 6.61%. The average number of passes it took until a 10 mm rut depth was 3,833. The average number of passes it took until a 20 mm rut depth was 7,140. The average creep slope of the three specimens is -0.0014 with an average stripping slope of -0.0031. The average stripping inflection point of the three specimens is 1,704. The rut

depths versus the wheel passes for the failed point in the three specimens are plotted in Figure 3.22 and the cross-sectional profiles of the three specimens at the failure point in Figure 3.23. Pictures of lab mixed WMA cores before and after testing can be seen from Figures 3.24, 3.25, 3.26 and 3.27. As can be seen from Figure 3.22, there are multiple spikes in the rut depth data, which may have been caused by pieces of aggregate and asphalt mix breaking off and affecting the height measurement. The stripping slope remains the same when these points were removed.

3.3.3 Lab Mixed PG 64-22 HMA

The test results and general information for the lab mixed HMA specimens using PG 64-22 binder are summarized in Table 3.12. As can be seen from the table, the average air void of the lab mixed HMA specimens was 6.98%. The average number of passes it took until a 10 mm rut depth was 6,450. The average number of passes it took until a 20 mm rut was 11,831. The average creep slope of the three specimens is -0.00106 with an average stripping slope of -0.001967. The average stripping inflection point of the three specimens is 4,044. The rut depths versus the wheel passes for the failed point in the three specimens are plotted in Figure 3.28 and the cross-sectional profiles of the three specimens at the failure point in Figure 3.29. Pictures of lab mixed HMA cores before and after testing can be seen from Figures 3.30, 3.31, 3.32 and 3.33.

3.3.4 Lab Mixed PG 64-22 WMA

The test results and general information for the lab mixed WMA specimens using PG 64-22 modified with 1.0% additive by asphalt content are summarized in Table 3.13. As can be seen from the table, the average air void of the lab mixed WMA specimens was 7.16%. The average number of passes it took until a 10 mm rut depth was 3,950.

The average number passes it took until a 20 mm rut depth was 7,758. The average creep slope of the three specimens is -0.0018 with an average stripping slope of -0.0026. The average stripping inflection point of the three specimens is 2,156. The rut depths versus the wheel passes for the failed point in the three specimens were plotted in Figure 3.34 and the cross-sectional profiles of the three specimens at the failure point in Figure 3.35. Pictures of lab mixed WMA cores before and after testing can be seen from Figures 3.36, 3.37, 3.38 and 3.39.

3.3.5 Summary Of Lab Mixed Hamburg Results

As shown in Table 3.14 the HMA specimens with PG 64-22 binder were superior to other lab mixed specimens tested. It was followed closely by HMA specimens using PG 58-28, WMA specimens using PG 58-28 modified with 1.5% additive content finally WMA specimens using PG 64-22 modified with 1.0% additive content. The HMA specimens that used PG 64-22 had an average wheel passes to failure of 11,832, an average creep slope of -0.00083, an average stripping slope of -0.0019, and an average stripping inflection point of 4,045.

It is somewhat surprising that the WMA specimens that used the PG 64-22 binder modified with 1.0% additive had less resistance to rutting damage than the WMA specimens using PG 58-28 modified with 1.5% additive. Although the PG 64-22 WMA mixture had a greater resistance to moisture damage than the PG 58-28 WMA mixture, it was more susceptible to rutting damage.

Aggregate	% in Mix	Source Location	Type	Gsb	Gsa	% Abs.
Porous Limestone	100.0	RPC - Conklin	A	2.633	2.715	1.14

Table 3.1: Aggregate information

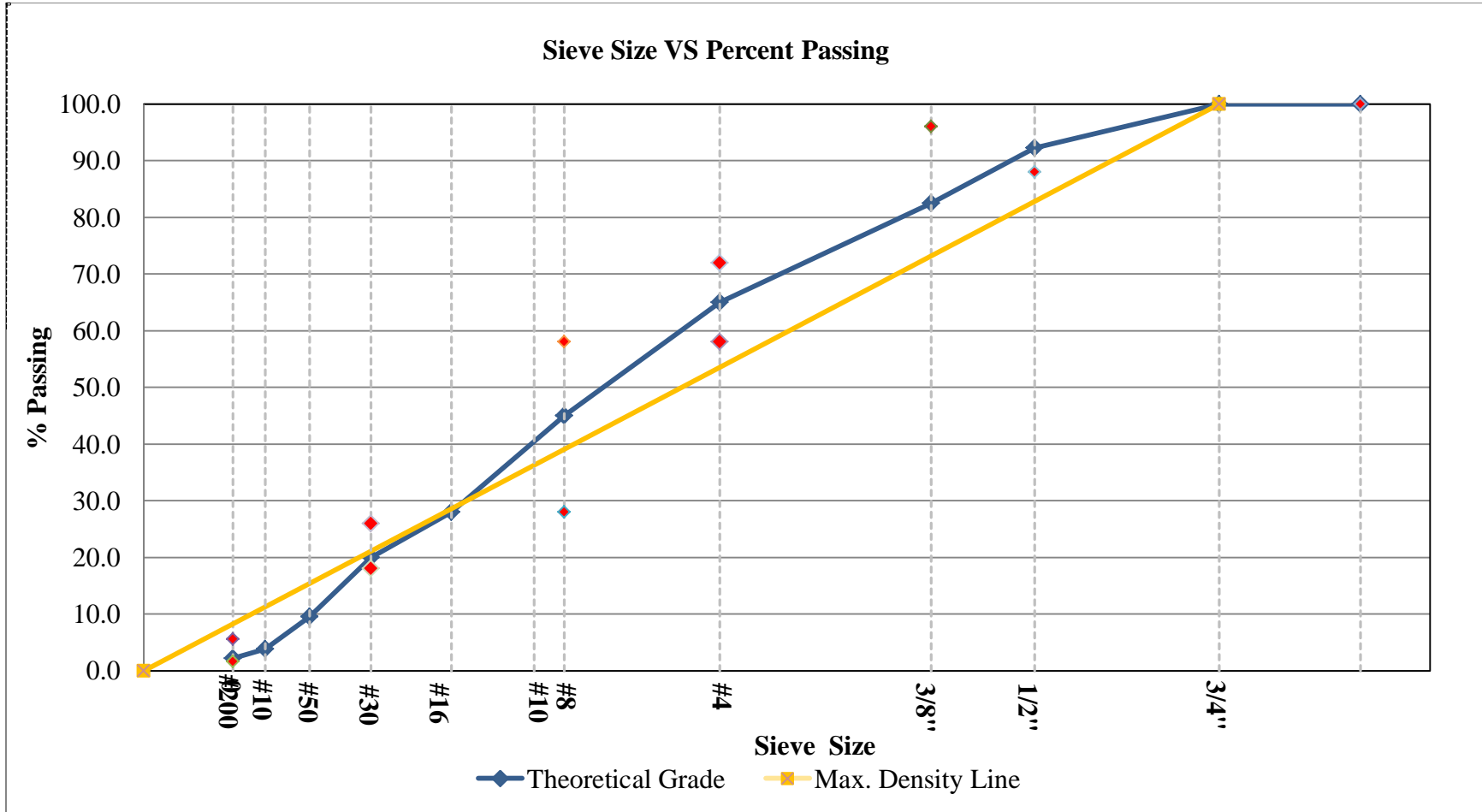

Figure 3.1: Lab mixed limestone gradation with tolerances

	Binder Content			
	5.00%	5.20%	5.65%	6.10%
% Air Voids @ N-Design	3.77	3.54	2.27	1.59
Gmb	2.4	2.4	2.405	2.415
Gmm	2.494	2.488	2.461	2.454
% Gmm @ N-Initial (Max: 90.5)	84.73	85.91	87.62	87.39
% GMM @ N-Max (Max 98.0)	94.89	XX	XX	XX
% VMA (Min: 14.0)	13.41	13.6	13.82	13.88
% VFA (Range: 65-78)	71.89	73.93	83.55	88.53
DP	0.86	0.82	0.75	0.68
Percent Water Absorption	0.65	0.67	0.24	0.2
Gb	1.036	1.036	1.036	1.036
Gsb	2.633	2.633	2.633	2.633
Gse	2.693	2.693	2.693	2.693
Percent Asphalt Absorption	0.88	0.88	0.88	0.88

Table 3.2: Volumetric data used to determine the OBC using PG 58-28 binder

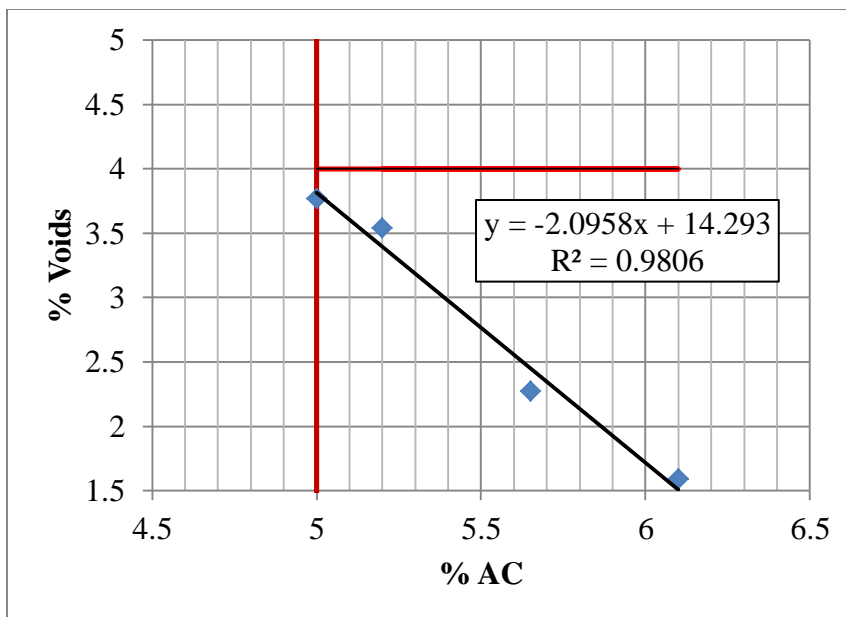

Figure 3.2: Percent air voids VS asphalt content (PG 58-28)

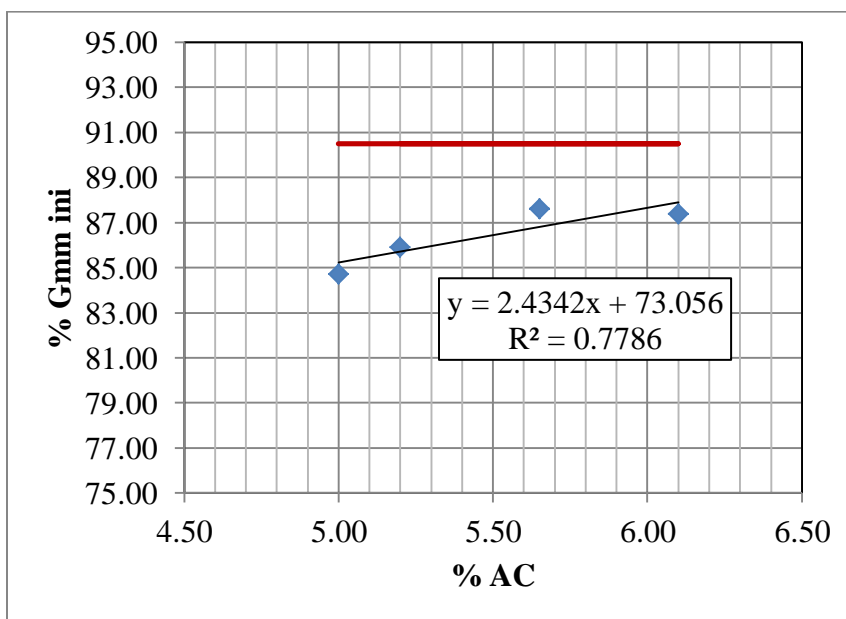

Figure 3.3: Percent Gmm @ N-initial VS asphalt content (PG 58-28)

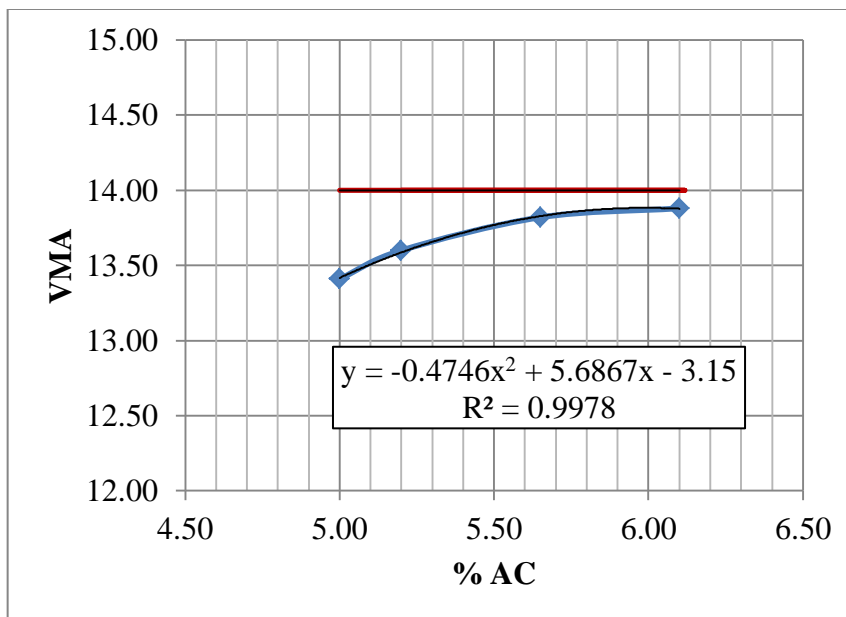

Figure 3.4: Percent VMA VS asphalt content (PG 58-28)

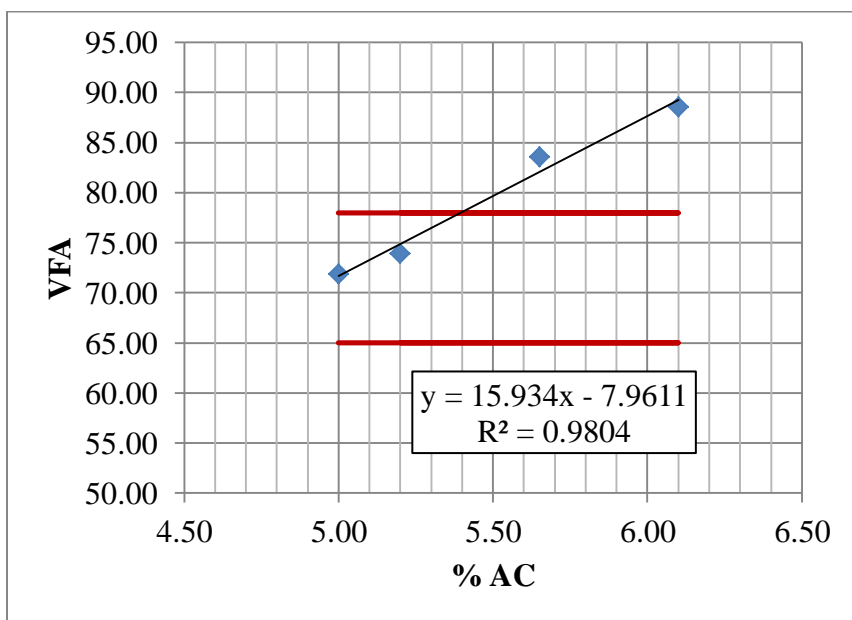

Figure 3.5: Percent VFA VS asphalt content (PG 58-28)

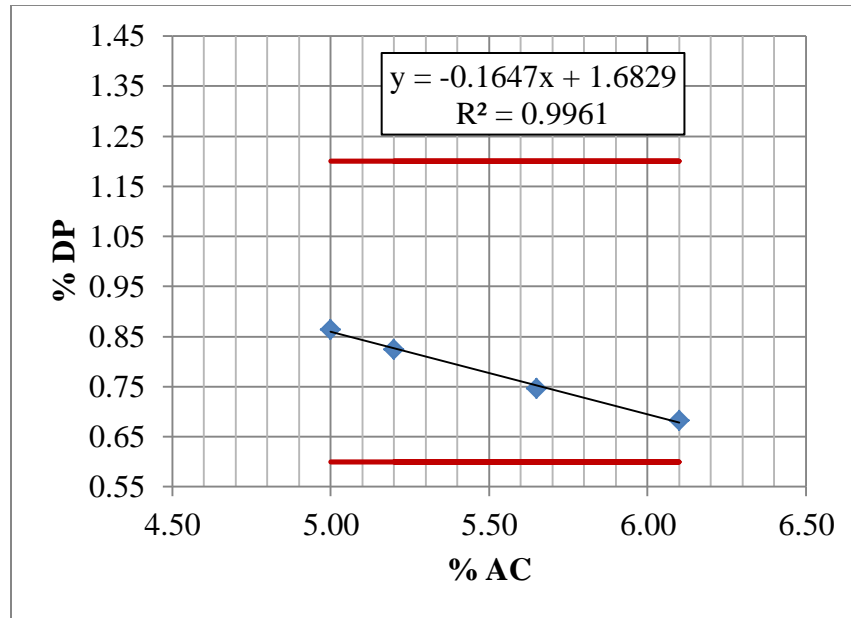

Figure 3.6: Percent DP VS asphalt content (PG 58-28)

Process	HMA PG 58-28	WMA PG 58-28 1.5% additive
Binder	145 C	135 C
Mixing	145 C	135 C
Aging	135 C	115 C
Compaction	135 C	115 C

Table 3.3: Temperatures during mixture design using PG 58-28

	Binder Content		
	5.00%	5.50%	6.00%
% Air Voids @ N-Design	4.27	3.37	2.55
Gmb	2.373	2.378	2.381
Gmm	2.479	2.461	2.443
% Gmm @ N-Initial (Max: 90.5)	87.22	89.14	90.79
% GMM @ N-Max (Max: 98.0)	95.88	XX	XX
% VMA (Min: 14.0)	14.38	14.65	15
% VFA (Range: 65-78)	70.33	76.98	82.98
DP	0.81	0.73	0.66
Percent Water Absorption	0.67	0.37	0.16
Gb	1.043	1.043	1.043
Gsb	2.633	2.633	2.633
Gse	2.672	2.672	2.672
Percent Asphalt Absorption	0.58	0.58	0.58

Table 3.4: Volumetric data used to determine the OBC with PG 64-22 binder

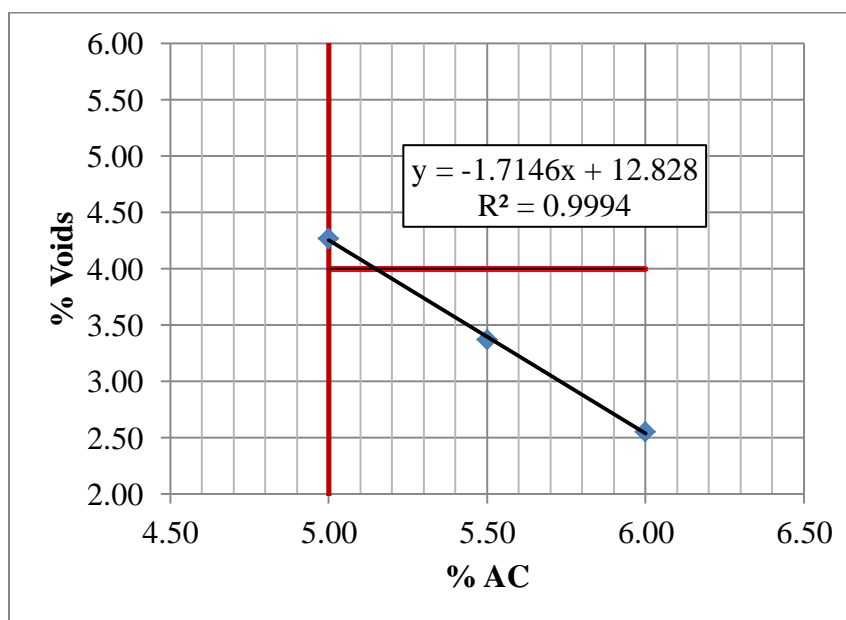

Figure 3.7: Percent air voids VS asphalt content (PG 64-22)

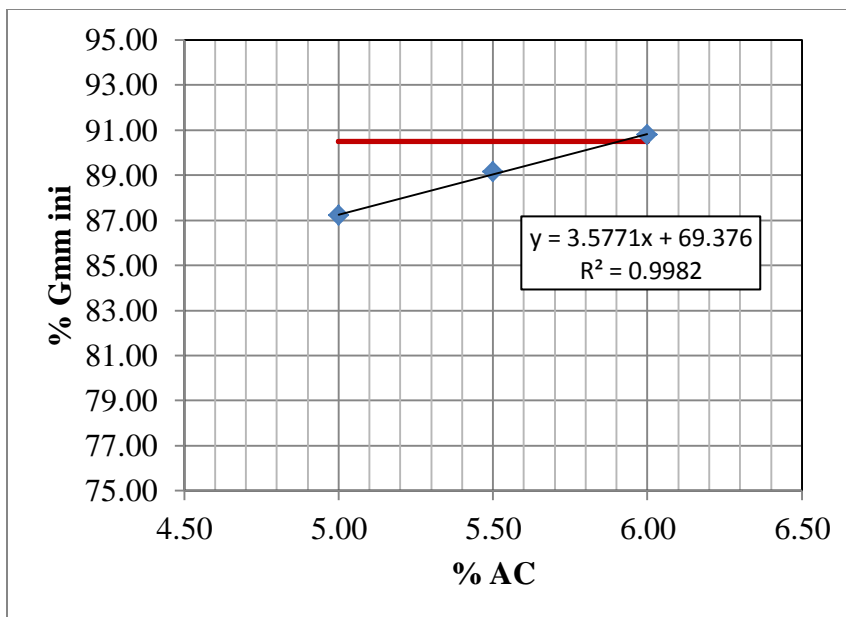

Figure 3.8: Percent Gmm @ N-initial VS asphalt content (PG 64-22)

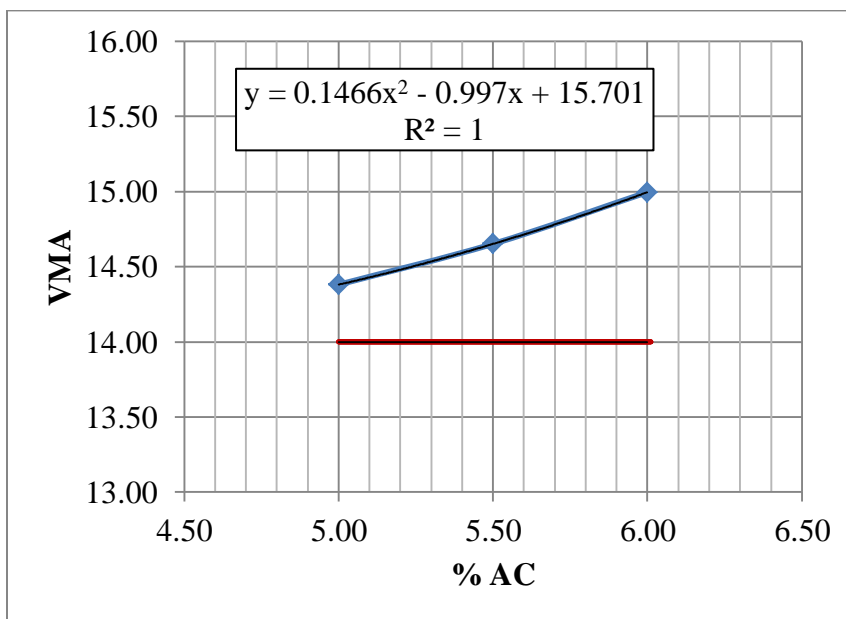

Figure 3.9: Percent VMA VS asphalt content (PG 64-22)

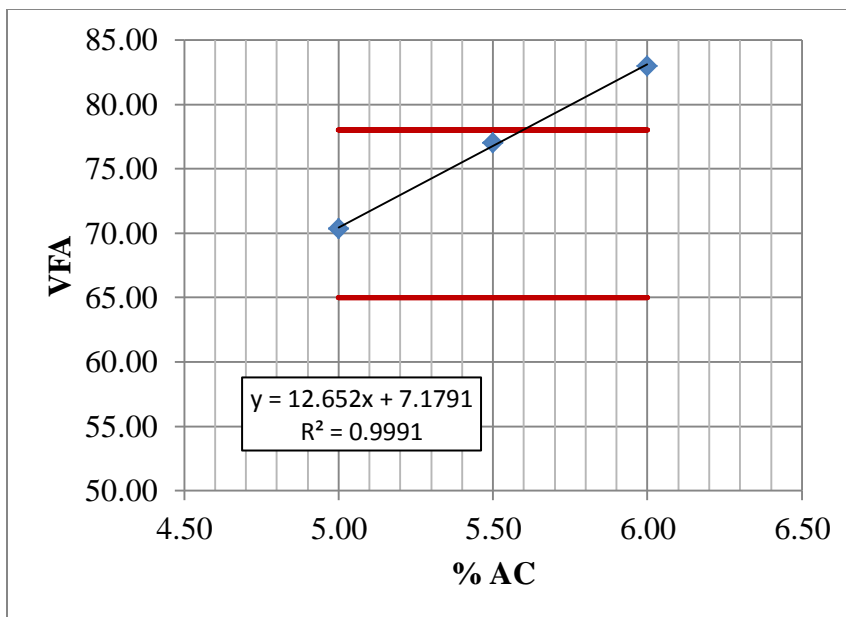

Figure 3.10: Percent VFA VS asphalt content (PG 64-22)

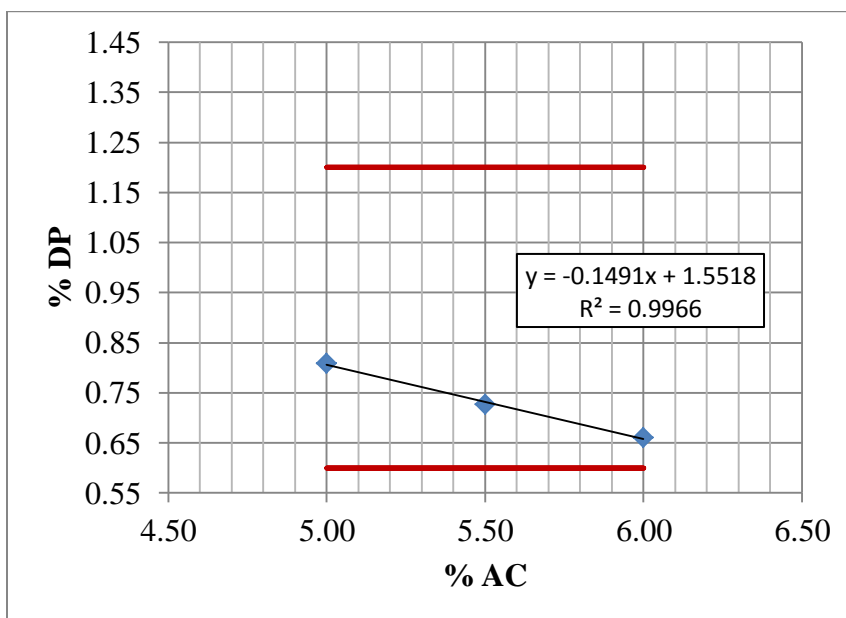

Figure 3.11: Percent DP VS asphalt content (PG 64-22)

Process	HMA PG 64-22	WMA PG 64-22 1.0% Additive
Binder	135	135 C
Mixing	135	135 C
Aging	135	115 C
Compaction	135	115 C

Table 3.5: Temperatures during mixture design using PG 64-22

Mix Type	Conditioning Requirements
HMA	4 hours at compaction temperature (135°C)
WMA	16 hours at 60°C followed by 2 hours at compaction temperature (115°C)

Table 3.6: Conditioning requirements for performance testing

Mix type	Spec ID	Dry	Wet	SSD	Height (mm)	Width (mm)	Gmb	Gmm	Voids	Sat wt	Saturation
Lab HMA Cond	LH1	1177.5	679.2	1186	66.88	100	2.323	2.494	6.84%	1202.3	71.54%
	LH2	1177.5	678.6	1186	66.84	100	2.321	2.494	6.95%	1204.4	76.28%
	LH3	1176.6	677.3	1183.5	66.98	100	2.324	2.494	6.80%	1202.7	75.81%
	LH4	1176.8	678	1185	66.83	100	2.321	2.494	6.93%	1202.7	73.69%
Lab HMA Uncond	LH5	1170	671	1176.8	66.82	100	2.313	2.494	7.25%	X	
	LH6	1173.2	675	1181.6	66.80	100	2.316	2.494	7.14%	X	
	LH7	1172.7	675.2	1182.3	66.83	100	2.313	2.494	7.27%	X	
	LH8	1163.6	670.1	1172.8	66.84	100	2.315	2.494	7.19%	X	
Lab WMA Cond	LW1	1165.5	668.5	1175.8	66.88	100	2.297	2.481	7.40%	1196	76.29%
	LW2	1166	669.7	1176.3	66.88	100	2.302	2.481	7.23%	1193.4	70.12%
	LW3	1167.6	672.8	1177.8	67.03	100	2.312	2.481	6.81%	1194.5	73.03%
	LW4	1164.4	667.4	1173.2	66.97	100	2.302	2.481	7.21%	1193	73.49%
Lab WMA Uncond	LW5	1164	669.1	1172.6	66.76	100	2.312	2.481	6.82%	X	
	LW6	1166	670.1	1175	66.90	100	2.309	2.481	6.92%	X	
	LW7	1165.8	668.9	1175	66.87	100	2.303	2.481	7.15%	X	
	LW8	1166.6	669.4	1175.8	67.05	100	2.304	2.481	7.15%	X	

Table 3.7: Volumetric information of specimens used for Modified Lottman Testing

Case	Sample ID	P, lb	Avg.D, in	Avg.H, mm	Avg.H, in	S _t	Avg.S _t , PSI	TSR	95% Confidence
Wet Set	LH1	1255.0	4	66.88	2.63	75.90	75.13	54.66	5.46
	LH2	1170.0	4	66.84	2.63	70.80			
	LH3	1370.0	4	66.98	2.64	82.73			
	LH4	1175.0	4	66.83	2.63	71.12			
Dry Set	LH5	2159.0	4	66.82	2.63	130.57	137.33	54.66	6.57
	LH6	2191.0	4	66.80	2.63	132.58			
	LH7	2372.0	4	66.83	2.64	143.23			
	LH8	2362.0	4	66.84	2.63	142.96			

Table 3.8: Indirect tensile strength of lab mixed HMA specimens

Case	Sample ID	P, lb	Avg.D, in	Avg.H, mm	Avg.H, in	S _t	Avg.S _t , PSI	TSR	95% Confidence
Wet Set	LW1	612.0	4	66.88	2.63	37.01	37.14	27.67	1.73
	LW2	593.0	4	66.88	2.63	35.86			
	LW3	597.0	4	67.03	2.64	36.02			
	LW4	657.0	4	66.97	2.64	39.68			
Dry Set	LW5	2233.0	4	66.76	2.63	135.29	134.26	27.67	2.93
	LW6	2183.0	4	66.90	2.63	131.97			
	LW7	2178.0	4	66.87	2.63	131.74			
	LW8	2288.0	4	67.05	2.64	138.02			

Table 3.9: Indirect tensile strength of lab mixed WMA specimens

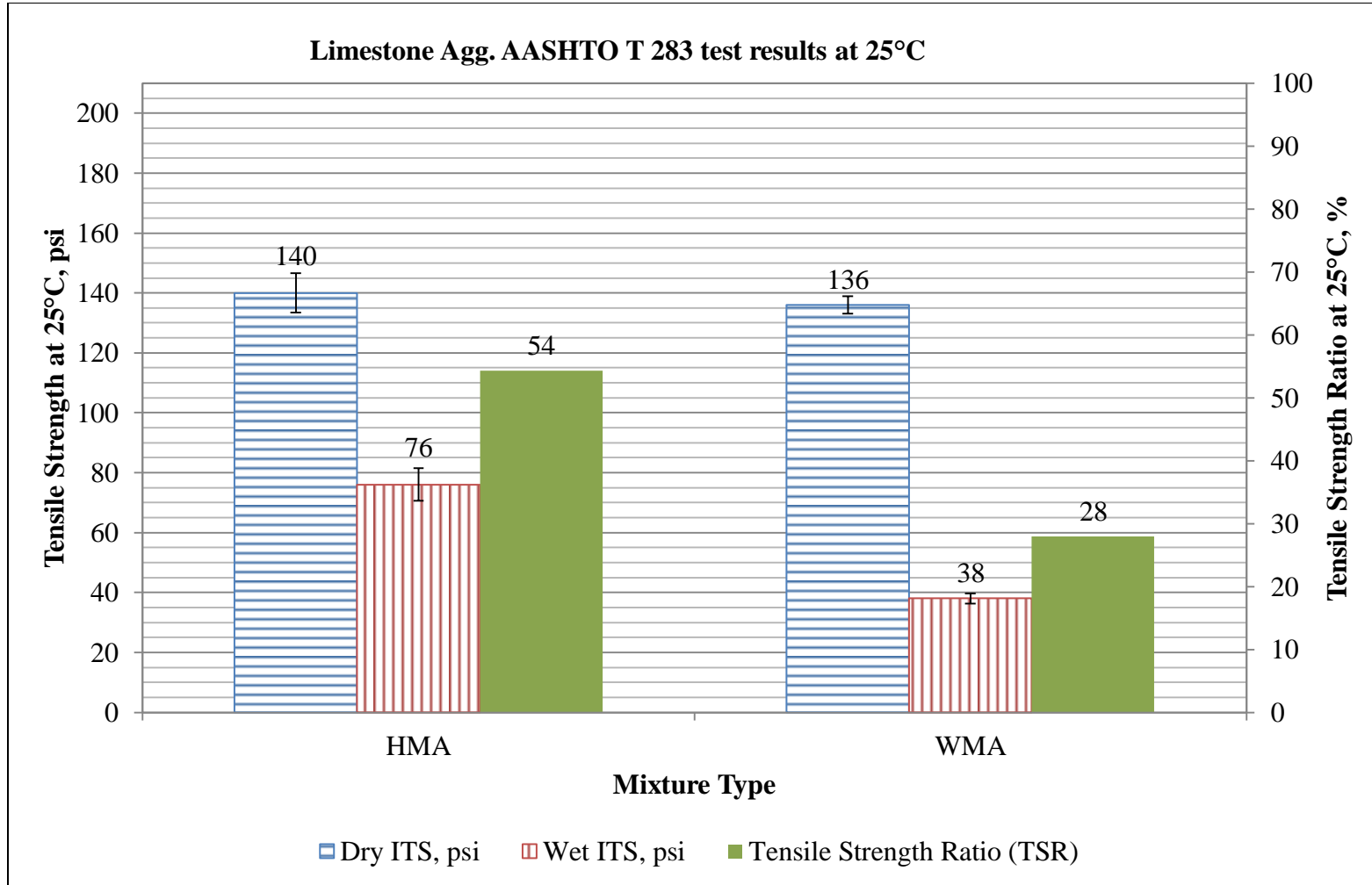

Figure 3.12: Indirect tensile strength and TSR of lab mixed HMA and WMA specimens using PG 58-28



Figure 3.13: Stripping effects on lab mixed HMA specimens



Figure 3.14: Stripping effects on lab mixed WMA specimens

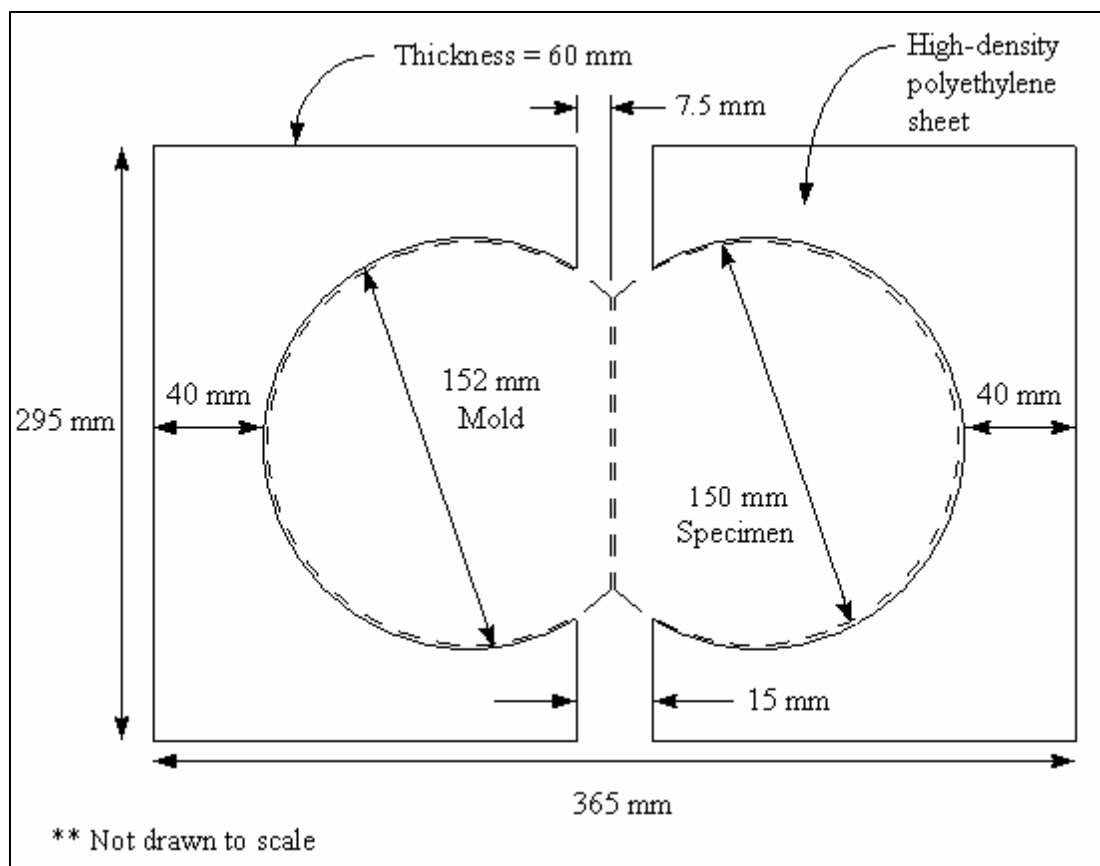

Figure 3.15: Dimensions of specimens and molds used in the Hamburg Wheel Tracking Test

Mixture	PG 58-28 HMA					
Test ID	LH1 (58-28)		LH2 (58-28)		LH3 (58-28)	
Specimen ID	LH1	LH2	LH3	LH4	LH5	LH6
Gmb	2.330	2.330	2.332	2.327	2.324	2.331
Gmm	2.494	2.494	2.494	2.494	2.494	2.494
Percent Air Voids	6.58	6.58	6.50	6.70	6.82	6.54
Average Air Voids	6.58		6.60		6.68	
Location in WT	Rear	Front	Rear	Front	Rear	Front
Wheel Passes to 10 mm Rut Depth	4,850		5,300		5,000	
Failed Core	X			X		X
Average Depth @ 10 mm	-7.27	-7.12	-6.29	-8.59	-6.14	-8.96
Wheel Passes to Failure	9,412		10,646		10,763	
Failed Core	X			X		X
Max Depth @ Failure	-20.03	-19.83	-17.6	-20.03	-18.37	-20.02
Data Point for Max Depth	6	7	6	9	6	9
Average Depth @ Failure	-12.88	-16.59	-13.26	-18.55	-11.94	-18.06
Creep Slope	-0.0008		-0.0007		-0.001	
Stripping Slope	-0.0023		-0.002		-0.0018	
SIP	1,930		2,500		489	

Table 3.10: Lab mixed PG 58-28 HMA Hamburg test data

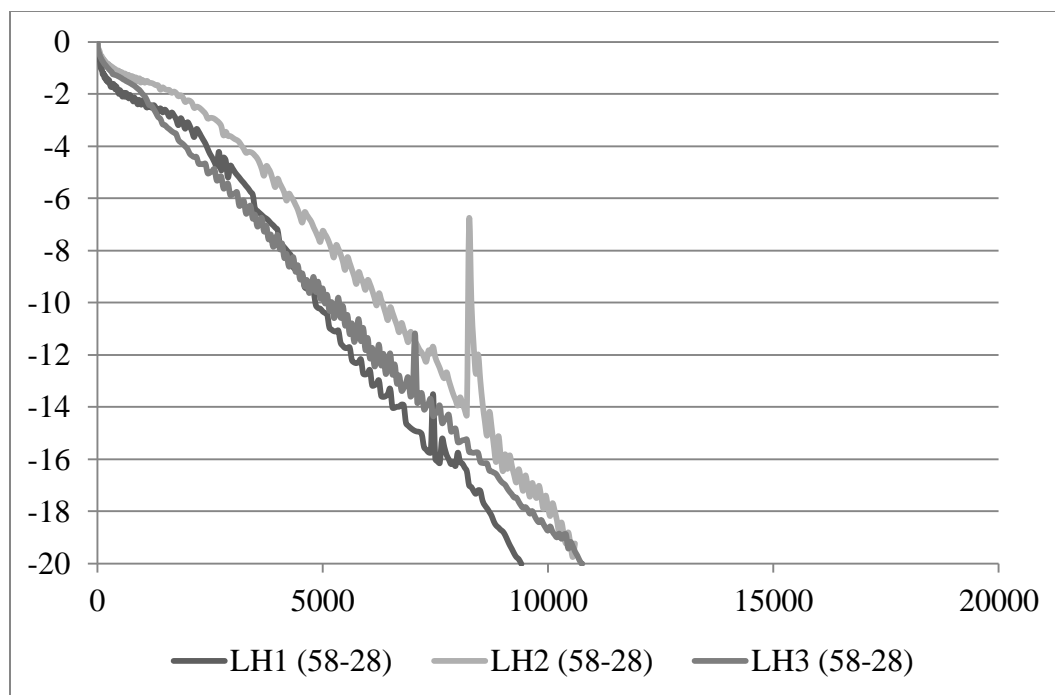

Figure 3.16: Lab mixed PG 58-28 HMA rut depth VS wheel passes

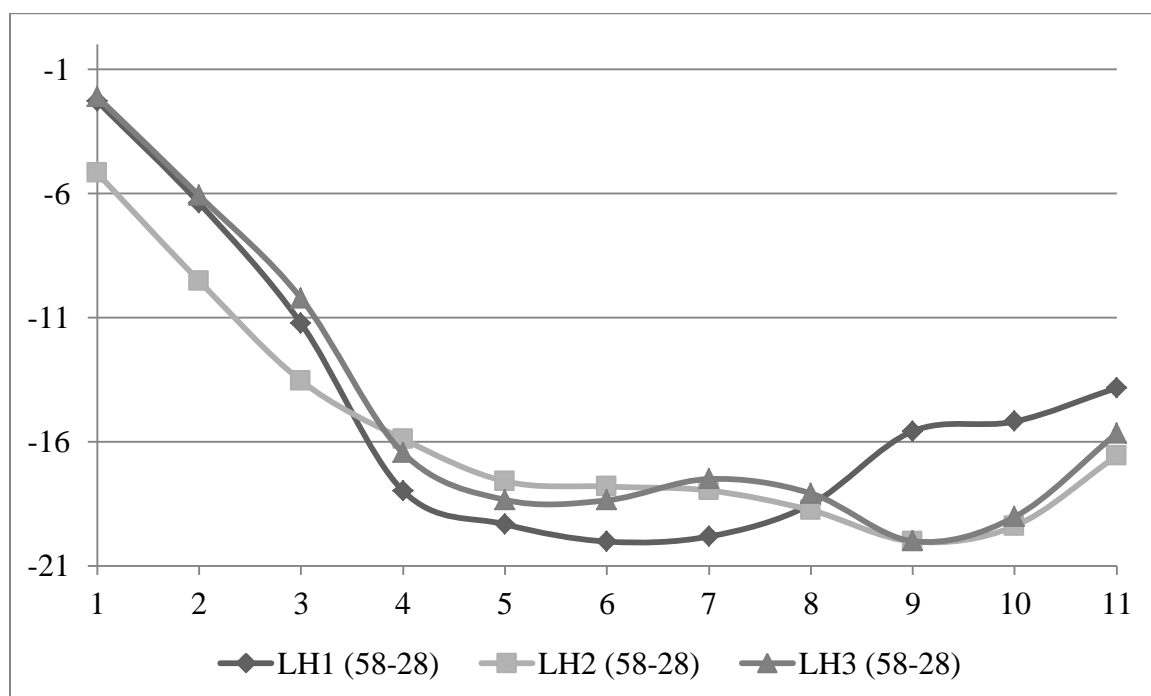

Figure 3.17: Lab mixed PG 58-28 HMA rut profile

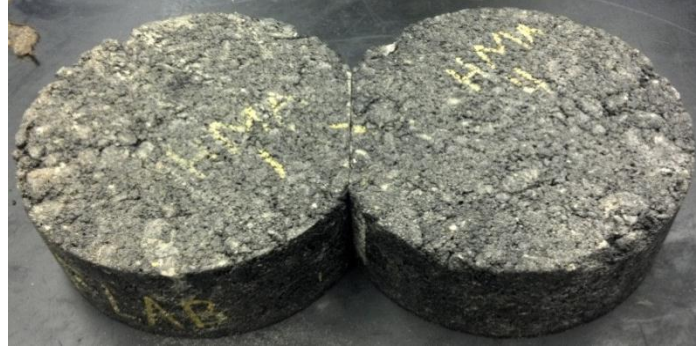

Figure 3.18: Test LH1 (PG 58-28) specimens before testing (top)



Figure 3.19: Test LH1 (PG 58-28) specimens before testing (side)



Figure 3.20: Test LH1 (PG 58-28) specimens after testing (top)



Figure 3.21: Test LH1 (PG 58-28) specimens after testing (side)

Mixture	PG 58-28 WMA					
Test ID	LW1 (58-28)		LW2 (58-28)		LW3 (58-28)	
Specimen ID	LW	LW2	LW3	LW4	LW5	LW6
Gmb	2.315	2.319	2.318	2.318	2.314	2.317
Gmm	2.481	2.481	2.481	2.481	2.481	2.481
Percent Air Voids	6.69	6.53	6.57	6.57	6.73	6.61
Average Air Voids	6.61		6.57		6.67	
Location in WT	Rear	Front	Rear	Front	Rear	Front
Wheel Passes to 10 mm Rut Depth	4,150		32,000		4,150	
Failed Core		X		X		X
Average Depth @ 10 mm	-7.77	-8.75	-4.36	-7.43	-6.67	-9.52
Wheel Passes to Failure	7,100		6,978		7,342	
Failed Core		X		X		X
Max Depth @ Failure	-19.69	-20.01	-19.37	-20.00	-19.14	-20.02
Data Point for Max Depth	6	7	6	7	6	7
Average Depth @ Failure	-13.76	-16.58	-8.91	-16.79	-12.98	-17.17
Creep Slope	-0.0013		-0.0016		-0.0012	
Stripping Slope	-0.0033		-0.0029		-0.0031	
SIP	2,301		268		2,543	

Table 3.11: Lab mixed PG 58-28 WMA Hamburg test data

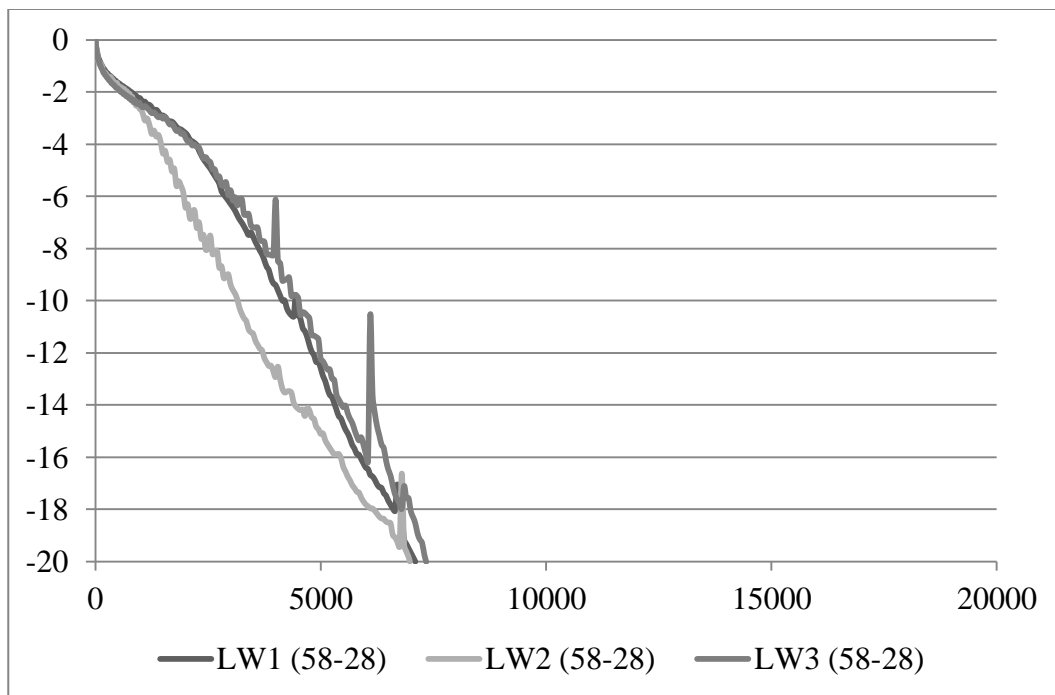

Figure 3.22: Lab mixed PG 58-28 WMA rut depth VS wheel passes

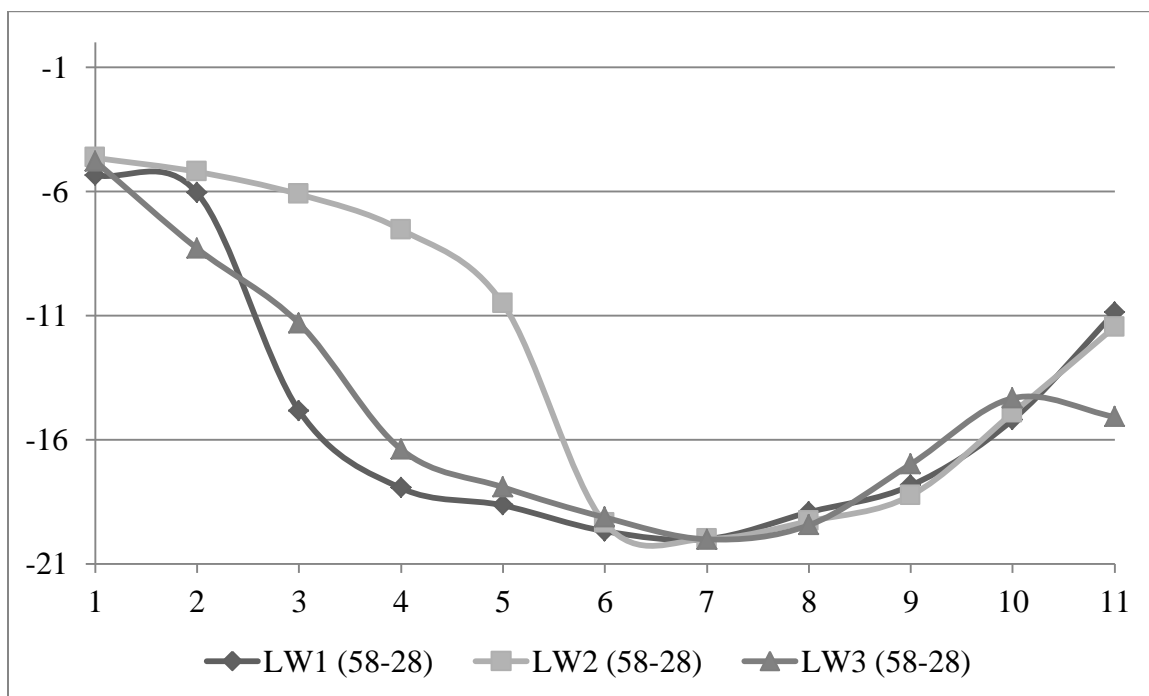

Figure 3.23: Lab mixed PG 58-28 WMA rut profile



Figure 3.24: Test LW2 (PG 58-28) specimens before testing (top)



Figure 3.25: Test LW2 (PG 58-28) specimens before testing (side)

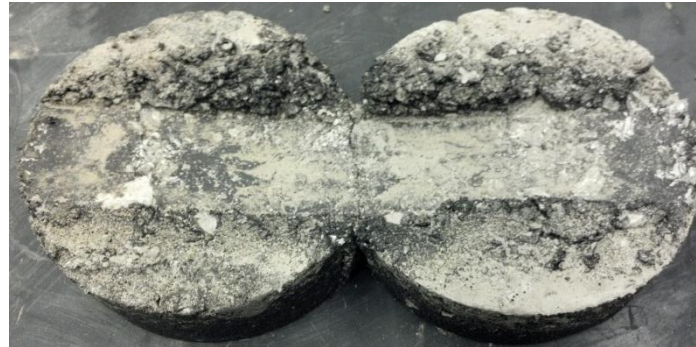

Figure 3.26: Test LW2 (PG 58-28) specimens after testing (top)



Figure 3.27: Test LW2 (PG 58-28) specimens after testing (side)

Mixture	PG 64-22 HMA					
Test ID	LH1 (64-22)		LH2 (64-22)		LH3 (64-22)	
Specimen ID	LH1	LH2	LH3	LH4	LH5	LH6
Gmb	2.303	2.304	2.309	2.302	2.312	2.298
Gmm	2.479	2.479	2.479	2.479	2.479	2.479
Percent Air Voids	7.10	7.06	6.86	7.14	6.74	7.30
Average Air Voids	7.08		6.86		7.02	
Location in WT	Rear	Front	Rear	Front	Rear	Front
Wheel Passes to 10 mm Rut Depth	5,750		6,600		7,000	
Failed Core		X	X			X
Average Depth @ 10 mm	-6.09	-9.32	-7.71	-6.89	-7.08	-9.27
Wheel Passes to Failure	11,630		12,423		11,442	
Failed Core		X	X			X
Max Depth @ Failure	-16.96	-20.04	-20.04	-19.67	-17.44	-20.01
Data Point for Max Depth	6	9	6	7	6	9
Average Depth @ Failure	-11.43	-18.98	-13.15	-17.51	-11.78	-19.07
Creep Slope	-0.001		-0.0011		-0.0011	
Stripping Slope	-0.0018		-0.0018		-0.0023	
SIP	1,302		4,798		6,034	

Table 3.12: Lab mixed PG 64-22 HMA Hamburg test data

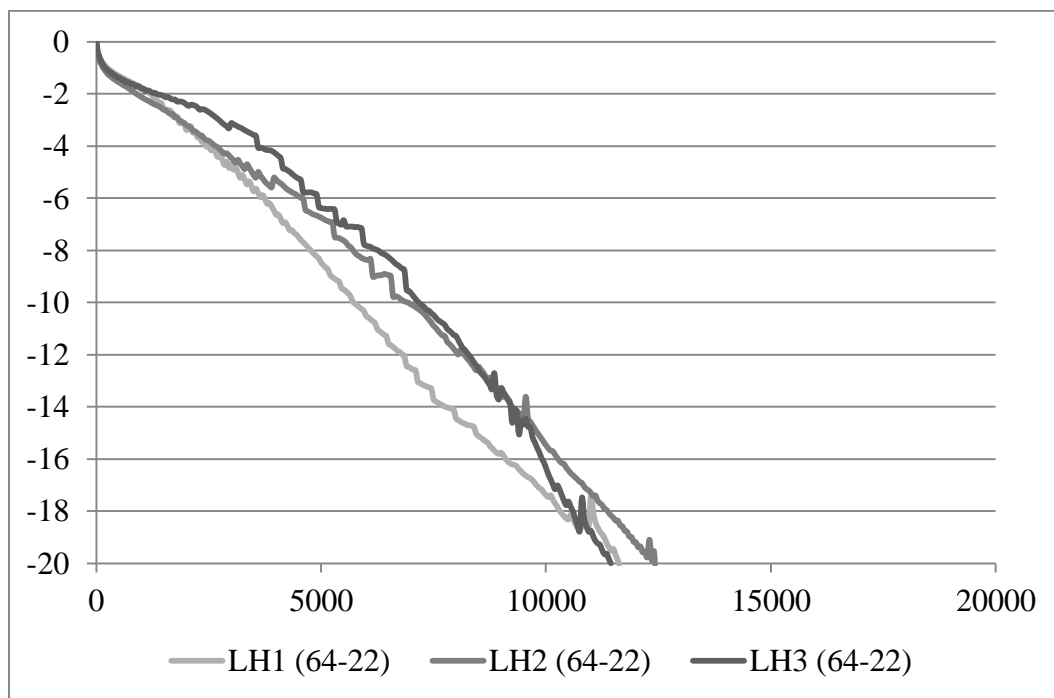

Figure 3.28: Lab mixed PG 64-22 HMA rut depth VS wheel passes

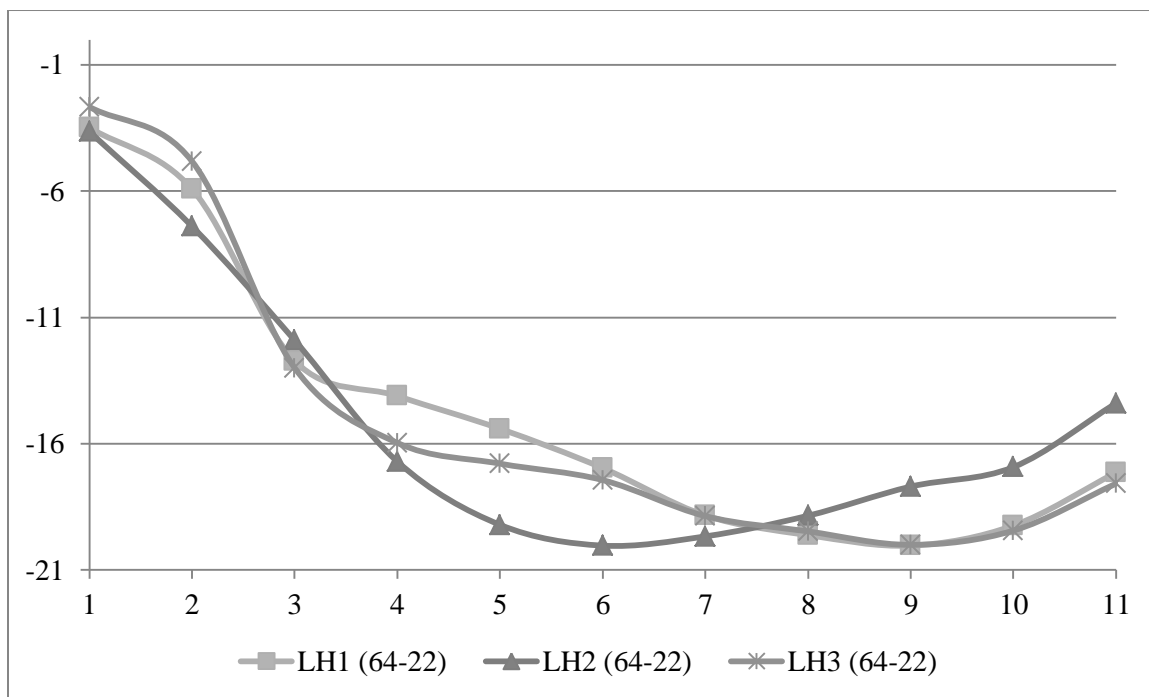

Figure 3.29: Lab Mixed PG 64-22 HMA rut profile



Figure 3.30: Test LH1 (64-22) specimens before testing (top)

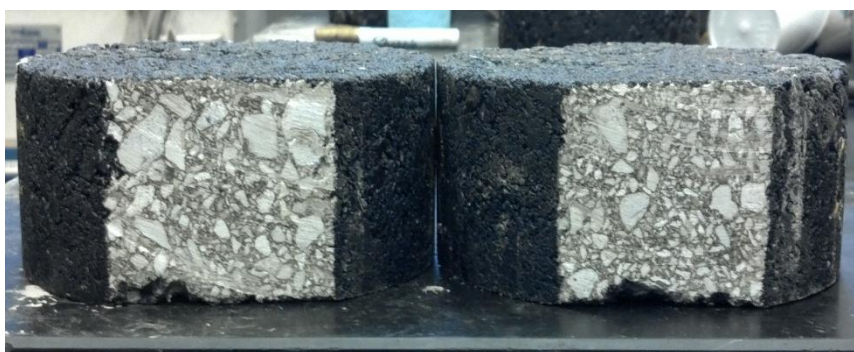

Figure 3.31: Test LH1 (64-22) specimens before testing (side)



Figure 3.32: Test LH1 (64-22) specimens after testing (top)



Figure 3.33: Test LH1 (64-22) specimens after testing (side)

Mixture	PG 64-22 WMA					
Test ID	LW1 (64-22)		LW2 (64-22)		LW3 (64-22)	
Specimen ID	LW	LW2	LW3	LW4	LW5	LW6
Gmb	2.284	2.291	2.289	2.287	2.292	2.286
Gmm	2.465	2.465	2.465	2.465	2.465	2.465
Percent Air Voids	7.34	7.06	7.14	7.22	7.02	7.26
Average Air Voids	7.20		7.14		7.14	
Location in WT	Rear	Front	Rear	Front	Rear	Front
Wheel Passes to 10 mm Rut Depth	3,800		4,150		3,900	
Failed Core	X			X	X	
Average Depth @ 10 mm	-7.08	-8.95	-6.65	-9.05	-7.52	-8.11
Wheel Passes to Failure	7,532		7,850		7,892	
Failed Core	X			X		X
Max Depth @ Failure	-20.05	-19.97	-18.6	-20.01	-17.56	-20.11
Data Point for Max Depth	6	7	6	7	5	10
Average Depth @ Failure	-13.24	-18.76	-11.35	-17.60	-12.71	-17.56
Creep Slope	-0.0021		-0.0016		-0.0017	
Stripping Slope	-0.0026		-0.0026		-0.0026	
SIP	1,868		2,895		1,706	

Table 3.13: Lab mixed PG 64-22 WMA Hamburg test data

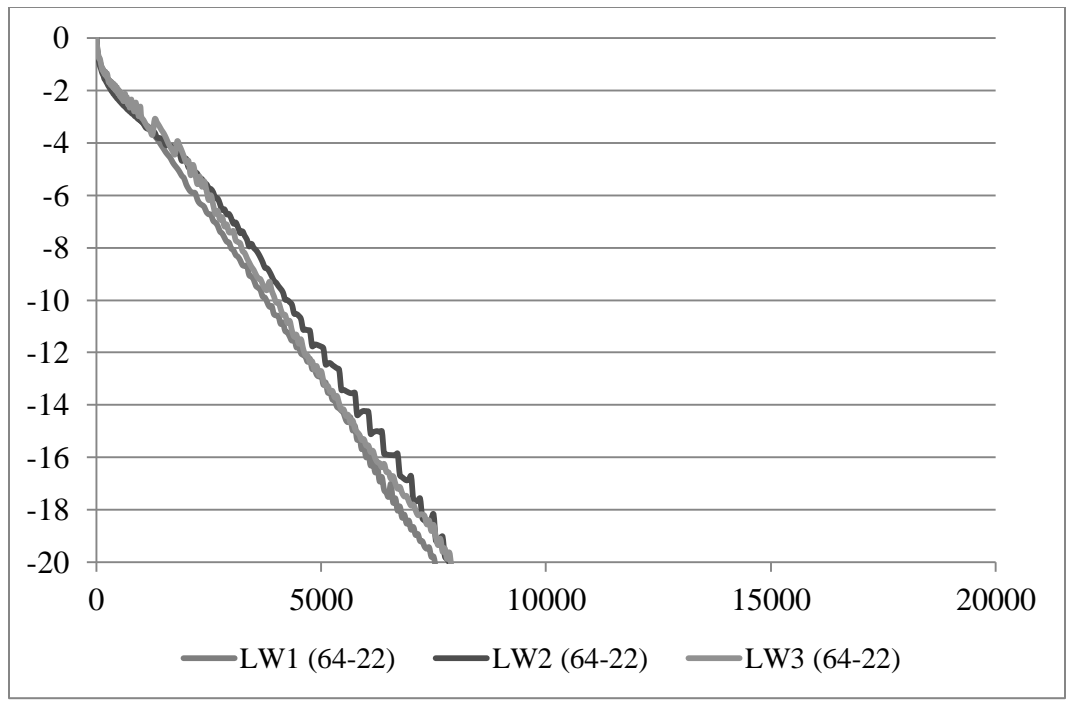

Figure 3.34: Lab mixed PG 64-22 WMA rut depth VS wheel passes

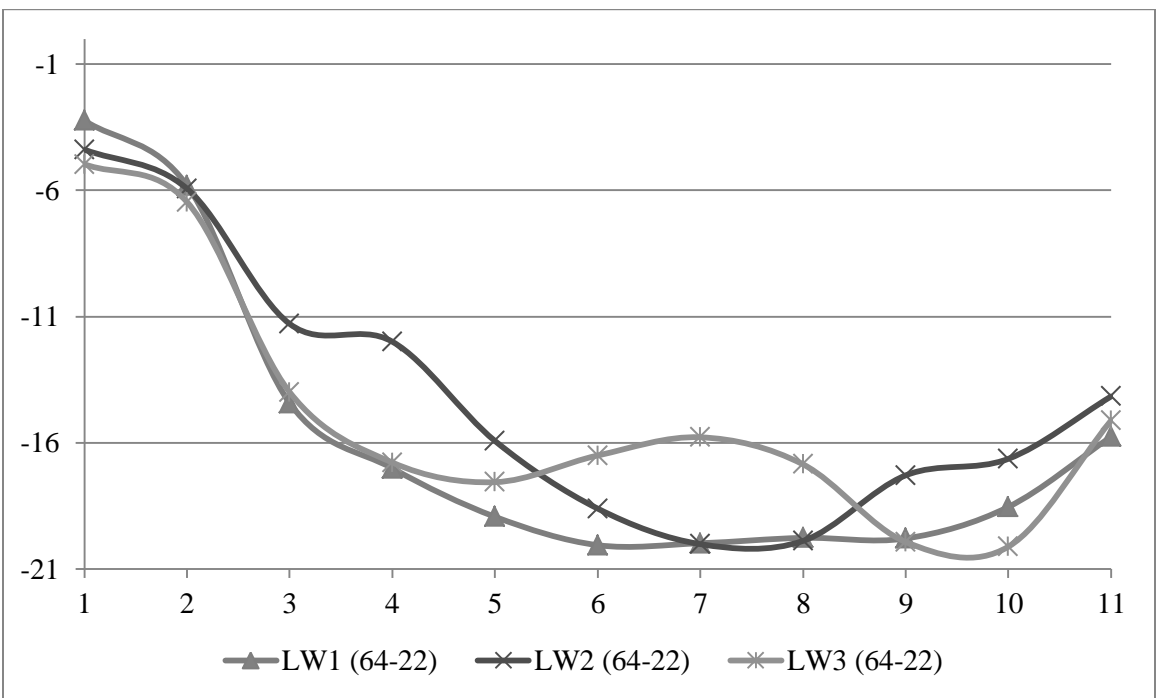

Figure 3.35: Lab Mixed PG 64-22 WMA rut profile



Figure 3.36: Test LW3 (64-22) specimens before testing



Figure 3.37: Test LW3 (64-22) specimens before testing



Figure 3.38: Test LW3 (64-22) specimens after testing



Figure 3.39: Test LW3 (64-22) specimens after testing

Mixture	HMA (PG 58-28)	HMA (PG 64-22)	WMA (PG 58-28 + 1.5% Additive)	WMA (PG 64-22 + 1.0% Additive)
Average Voids	6.62	6.99	6.62	7.17
Average Passes to Failure	10,274	11,832	7,140	7,758
Average Creep Slope	-0.00107	-0.00083	-0.00137	-0.0018
Average Stripping Slope	-0.00203	-0.00197	-0.0031	-0.0026
Average SIP	1,640	4,045	1,704	2,156

Table 3.14: Summary of data collected during Hamburg Wheel Tracking Tests

CHAPTER 4

CONSTRUCTION OF A PAVEMENT USING THE SELECTED ADDITIVE IN IOWA

One of the main objectives of this study was to construct a pavement using the selected additive in Iowa. On August 15th 2011 a stretch of pavement in Iowa City was resurfaced using the WMA additive that was selected for study in this project. The opportunity was taken to observe the construction as well as gather samples for laboratory testing. HMA samples using the same mixture design were also sampled from a similar resurfacing job in Iowa City so testing results could be compared.

4.1 Field Mixture Design

Both job sites called for a 1 million ESAL 1/2 inch surface mixture as well as a 1 million ESAL 1/2 inch base mix. Both mixtures were designed by L.L. Pelling Company located in Cedar Rapids Iowa. The aggregate was a combination of five stock piles including sand, man sand, 3/8 inch aggregate, 5/8 inch aggregate and RAP. More information including Gsb and absorption of the aggregates are summarized in Table 4.1. The individual aggregate gradations are summarized in Figure 4.1 and the combined gradation along with the tolerances found in Figure 4.2.

A PG64-22 asphalt binder was selected for this project, which is a typical binder used in Iowa with a specific gravity of 1.043 at 25°C. Lab compacted specimens using PG 64-22 binder at 5.00, 5.15, and 6.00% binder contents were produced with the design gyrations of 76, the initial gyrations of 7 and the maximum gyrations of 117. Specimens produced at 5.50% asphalt content had 4.0% air voids at 76 gyrations. The specimens produced at 5.50% asphalt content met all of the criteria set forth by the Iowa DOT

including Gmm @ N-initial, Gmm at N-design, %VMA, %VFA, and film thickness. A separate mix design was not needed for the WMA because the asphalt absorption of the mixture was under 1.0%. Additional mixture data can be found from Table 4.2 and air void, Gmm @ N-initial, VMA and VFA are plotted against AC content in Figure 4.3, 4.4, 4.5, 4.6 and 4.7, respectively.

4.2 Project Sites

Material for the project was gathered from two job sites in Iowa City that used the same mix design apart from additives and temperatures. The WMA project was located on Capitol Street and the HMA project on Miami Drive. All pavement resurfacing projects planned for the 2012 fiscal year are shown in Figure 4.8. A total of 7593 linear feet of pavement were milled and resurfaced using a 1.5" base course under a 1.5" surface course. 1,046 tons of asphalt was needed for the base course throughout the city and 1,416 tons for the surface course. The WMA project on Capitol Street was 670 linear feet and used 308 tons of base mix and 327 tons of surface mix. As summarized in Table 4.3, the aggregate and binder for the WMA mixture was mixed at 135°C(275°F), placed at 115°C(239°F) and compacted at 110°C(230°F). The aggregate and binder for the HMA mixtures were mixed at 165°C(329°F), placed at 145°C(293°F) and compacted at 135°C(275°F).

4.2.1 WMA Project On Capitol Street

The WMA job site, as shown in Figure 4.9, is located on Capitol Street in Iowa City between Prentis Street and Court Street. 3,870 square yards of 3 inches thick HMA was milled and replaced with a 1.5 inch base and 1.5 inch surface course on a 670 foot by 50 foot wide section of roadway. A total of 308 tons of a 1 million ESAL 1/2 inch base

mix and a total of 327 tons of a 1 million ESAL 1/2 inch surface mix were applied. The asphalt binder used in this WMA project was heated to 135°C(275°F) before mixing with the aggregate at 135°C(275°F). The asphalt mixture was stored in a silo until it was ready to be loaded onto dump trucks at 130°C(266°F). It was then transported to the jobsite and placed on top of the base course at 115°C(239°F). The asphalt mixture was then compacted at a temperature of 110°C(230°F). The freshly placed WMA mixtures were sampled by L.L. Pelling Co. to determine the volumetric properties. It was determined that the average air void of laboratory-compacted specimens was 3.91% based on a Gmm of 2.369 and a Gmb of 2.467. The film thickness of the mixture was 9.4 mm and the VMA was 14.8%, both within their specification limits. Field cores were made from the pavement to determine field voids. Based on seven cores, as shown in Table 4.4 the average field density was 2.240 resulting in a Gmb of 94.801% and 9.0% air void.

4.2.2 HMA Project On Miami Drive

The HMA job site, as shown in Figure 4.10, is located on Miami Drive in Iowa City starting 280 feet off of Lakeside drive and continuing until it reaches Hollywood Boulevard. 3,720 square yards of 3 inches thick HMA was milled and replaced with a 1.5 inch base and 1.5 inch surface course on a 1,205 foot by 25 foot wide section of roadway. A total of 276 tons of a 1 million ESAL 1/2 inch base mix and a total of 335 tons of a 1 million ESAL 1/2 inch surface mix were applied. The asphalt binder used in this HMA project was heated to 155°C(311°F) before mixing with the aggregate at 165°C(329°F). The asphalt mixture was stored in a silo until it was ready to be loaded onto dump trucks at 160°C(320°F). It was then transported to the jobsite and placed on

top of the base course at 145°C(293°F). The asphalt mixture was then compacted at a temperature of 135°C(275°F). The freshly placed HMA mixture was sampled by L.L. Pelling Co. to determine the volumetric properties. It was determined that the average air void of laboratory-compacted specimens was 4.40% based on a Gmm of 2.476 and a Gmb of 2.366. The film thickness of the mixture was 8.9 mm and the VMA was 14.9%, both within their specification limits. Field cores were made from the pavement to determine field voids. Based on seven cores, as shown in Table 4.5 the average field density was 2.302 resulting in a Gmb of 97.307% and 7.0% air void.

4.2.3 Summary Of Project Sites

Volumetric data obtained from field cores of HMA and WMA are summarized in Table 4.6. Both sites used roughly the same amount of material for both the base and surface course although Capitol Street was twice as wide as Miami. Samples from Capitol Street exhibited lower Gmm values than those from Miami Drive. This is unexpected since the mixtures contain the same amount of binder and aggregate. The higher field voids of the cores from Capitol Street than those from Miami Drive may indicate that the WMA mixture was slightly harder to compact than the HMA mixture. The average percent density of the Capitol Street field cores was 94.801% of the lab-compacted specimens whereas that of the Miami Drive cores was 97.307%. There was a difference in film thickness between the two sites as well. This calculation is based on effective binder content and aggregate gradation. Since the WMA absorbed less binder content the effective binder content was higher. The loose sample sent for gradation was also slightly more dense. These two factors led to a larger film thickness in the WMA.

There was no controlled compaction procedure and a future study should be performed to evaluate the influence of the compactive efforts on the field density

4.3 Modified Lottman Test Results

The Modified Lottman Test was performed on both HMA and WMA specimens. The data for the cores are summarized in Table 4.7, which shows the volumetric data of HMA and WMA specimens (The F in the specimen ID stands for lab mixed while the H and W stand for HMA and WMA respectively).

As can be seen from Table 4.7, the cores were divided into the unconditioned and conditioned group based on air void content. The average air void for the HMA conditioned specimens was 6.92% whereas 6.95% for the unconditioned specimens. Similarly for the WMA specimens, the conditioned specimens had an average air void of 6.88% whereas 7.05% for the unconditioned specimens.

Indirect tensile strength test results and the TSR values are summarized in Tables 4.8 and 4.9 for the HMA and WMA specimens respectively. The average TSR value for HMA specimens is 76.22 whereas the TSR value for WMA specimens is 74.94. These values are lower than the Superpave criterion of 80% and they are plotted in Figure 4.11

To examine the effects of stripping between the asphalt and aggregates, the conditioned specimens are broken to halves for a visual observation. As shown in Figure 4.12 and 4.13, respectively, both HMA and WMA specimens seem to experience a high amount of stripping. Upon closer inspection it was determined that most of the aggregate seen was caused by breaking rather than stripping. Both cores experienced roughly the same amount of stripping which lead to them having a similar TSR.

4.4 Hamburg Wheel Tracking Test Results

Hamburg Wheel Tracking Tests were performed on HMA and WMA field specimens immediately after sampling and seven months after sampling to determine the effects of aging.

4.4.1 Field Mixed HMA

The test results and general information for the field mixed HMA specimens tested are summarized in Table 4.10. As can be seen from the table, the average air void of the field mixed HMA specimens was 7.21%. The average number passes it took until a 10 mm rut depth was 11,108. The average number of passes it took until a 20 mm rut depth was 16,252. The average creep slope of the three specimens is -0.0006 with an average stripping slope of -0.0022. The average stripping inflection point of the three specimens is 10,387. The rut depths versus the wheel passes for the failed point in the three specimens are plotted in Figure 4.14 and the cross-sectional profiles of the three specimens at the failure point in Figure 4.15. Pictures of field mixed HMA cores before and after testing can be seen from Figures 4.16, 4.17, 4.18 and 4.19.

4.4.2 Field Mixed WMA

The test results and general information for the field mixed HMA specimens tested is summarized in Table 4.11. As can be seen from the table, the average air void of the field mixed WMA specimens was 6.86%. The average number of passes it took until a 10 mm rut depth was 6,150. The average number of passes it took until a 20 mm rut depth was 8,760. The average creep slope of the three specimens is -0.001 with an average stripping slope of -0.0039. The average stripping inflection point of the three specimens is 5,691. The rut depths versus the wheel passes for the failed point in the

three specimens are plotted in Figure 4.20 and the cross-sectional profiles of the three specimens at the failure point in Figure 4.21. Pictures of field mixed HMA cores before and after testing can be seen from Figures 4.22, 4.23, 4.24 and 4.25.

4.4.3 Aged Field Mixed HMA

The test results and general information for the aged field mixed HMA specimens tested is summarized in Table 4.12. As can be seen from the table, the average air void of the aged field mixed HMA specimens was 6.88%. The average number of passes it took a 10 mm rut depth was 16,550. All of the HMA specimens lasted 20,000 wheel passes before reaching a rut depth of 20 mm. The average number of wheel passes to a rut depth of 20 mm can be calculated from the linear equations generated from the stripping slopes. The average number wheel passes to a rut depth of 20 mm calculated from the stripping slopes was 26,834. The average creep slope of the three specimens is -0.00036 with an average stripping slope of -0.0001. The average stripping inflection point of the three specimens is 12,249. The rut depths versus the wheel passes for the failed point in the three specimens are plotted in Figure 4.26 and the cross-sectional profiles of the three tests at the failure point seen in Figure 4.27. Pictures of field mixed HMA cores before and after testing can be seen from Figures 4.28, 4.29, 4.30 and 4.31.

4.4.4 Aged Field Mixed WMA

The test results and general information for the aged field mixed WMA specimens tested are summarized in Table 4.13. As can be seen from the table, the average air void of the field mixed WMA specimens was 7.17%. The average number of passes it took until a 10 mm rut depth was 7,900. The average number of passes it took until a 20 mm rut depth was 12,163. The average creep slope of the three specimens is -0.00073 with

an average stripping slope of -0.0029. The average stripping inflection point of the three specimens is 8,253. The rut depths versus the wheel passes for the failed point in the three specimens are plotted in Figure 4.32 and the cross-sectional profiles of the three specimens at the failure point in Figure 4.33. Pictures of field mixed HMA cores before and after testing can be seen from Figures 4.34, 4.35, 4.36 and 4.37.

4.4.5 Summary Of Field Mixed Hamburg Results

As summarized in Table 4.14, the aged HMA mixture was superior to all other mixtures tested. It was followed by the HMA, aged WMA and the WMA. The aged HMA specimens had an estimated average passes to failure of 26,834, an average creep slope of -0.00036, an average stripping slope of -0.0001 and an average stripping inflection point of 12,249. It can be concluded that the aged HMA exhibited greater resistance to both rutting and moisture damage than others.

Aggregate	% in Mix	Source Location	Beds	Type	Friction Type	Gsb	% Abs	FAA
Sand	25.0	S & G Materials	Williams		4	2.634	0.47	41.3
Man Sand	21.0	RPC - Klein	21-22	A	5	2.630	1.12	47.1
3/8 inch	30.0	RPC - Conklin	3-10	A	4	2.642	1.01	47.1
5/8 inch	14.0	RPC - Klein	21-22	A	5	2.640	1.08	47.1
RAP	10.0	I-80 Shoulders	5.16			2.597	1.5	41.0

Table 4.1: Aggregate information

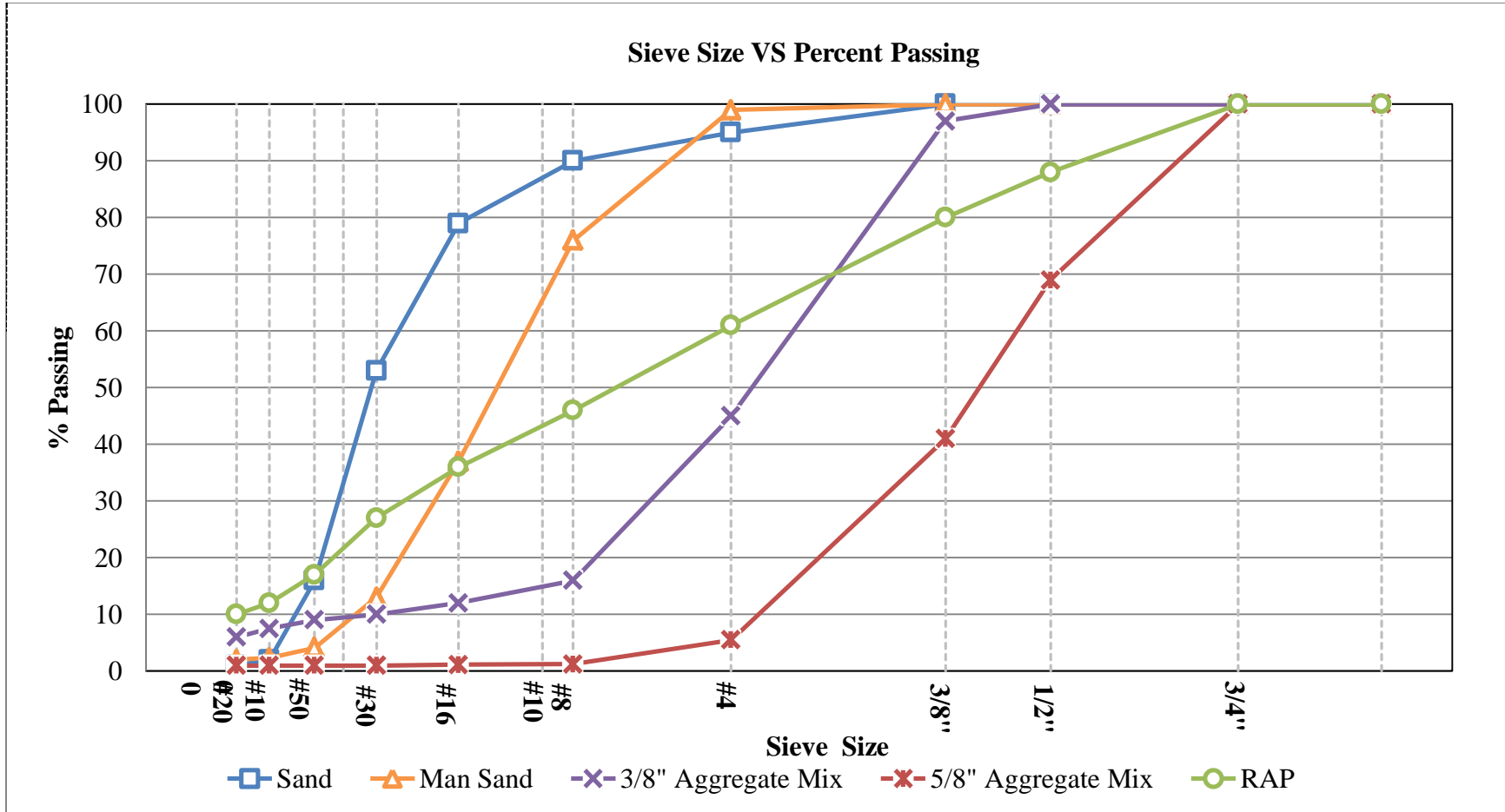

Figure 4.1: Individual aggregate gradations

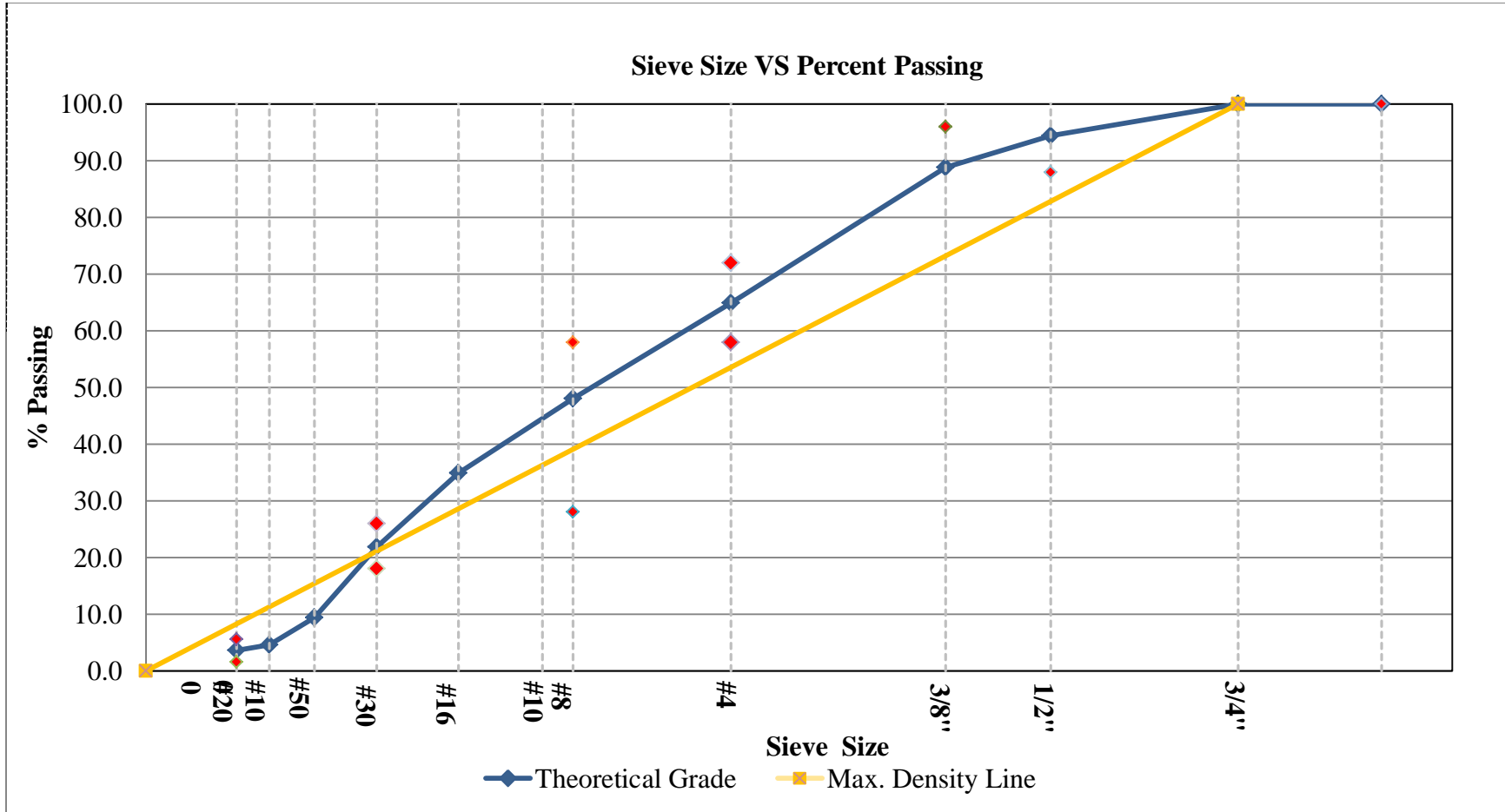

Figure 4.2: Combined aggregate gradation with tolerances

	Binder Content			
	5.00%	5.15%	5.50%	6.00%
% Air Voids @ N-Design	5	4.7	4	3
Gmb	2.351	2.349	2.357	2.368
Gmm	2.474	2.464	2.455	2.442
% Gmm @ N-Initial (Max: 90.5)	89.1	89.3	89.9	90.7
% GMM @ N-Max (Max 98.0)	95.9	96.1	96.9	97.9
% VMA (Min: 14.0)	15.2	15.4	15.4	15.5
% VFA (Range: 65-78)	67.2	69.6	74	80.4
Gsb	2.633	2.633	2.633	2.633
Gse	2.667	2.661	2.666	2.671

Table 4.2: Asphalt mixture properties

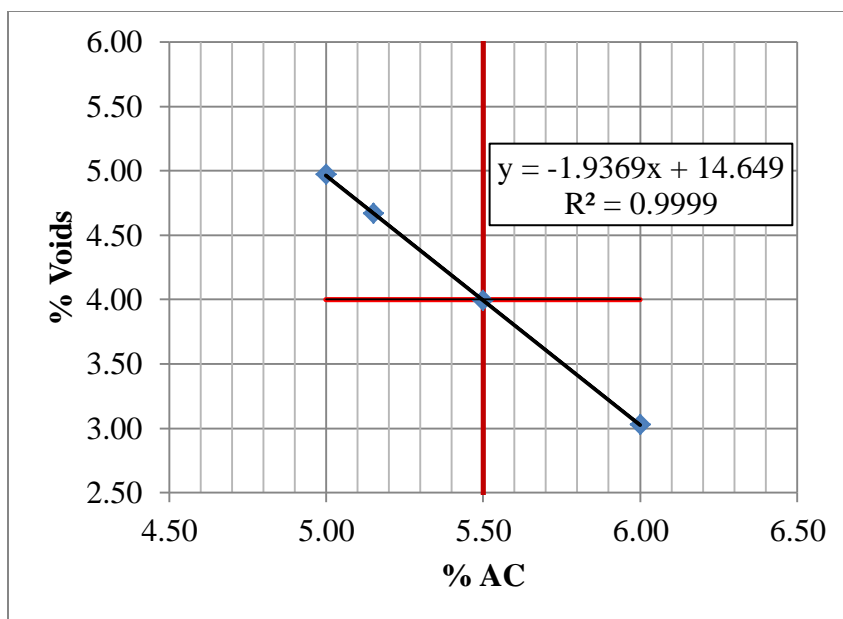

Figure 4.3: Percent air voids VS asphalt content

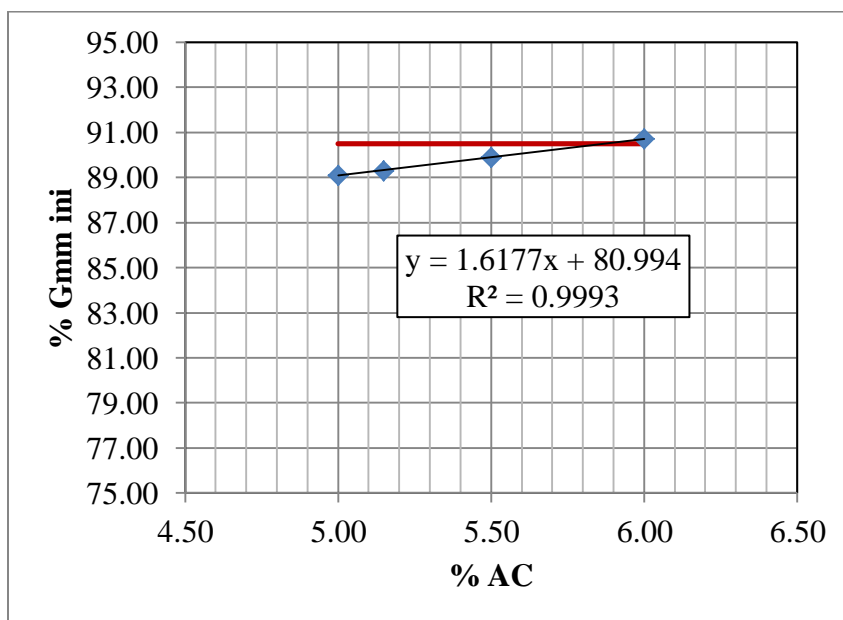

Figure 4.4: Percent Gmm @ N-initial VS asphalt content

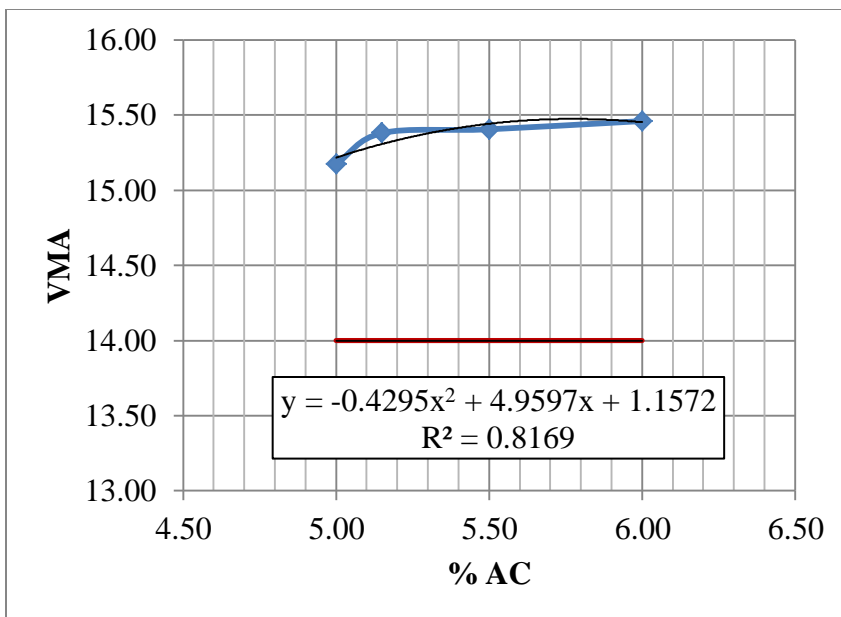

Figure 4.5: Percent VMA VS asphalt content

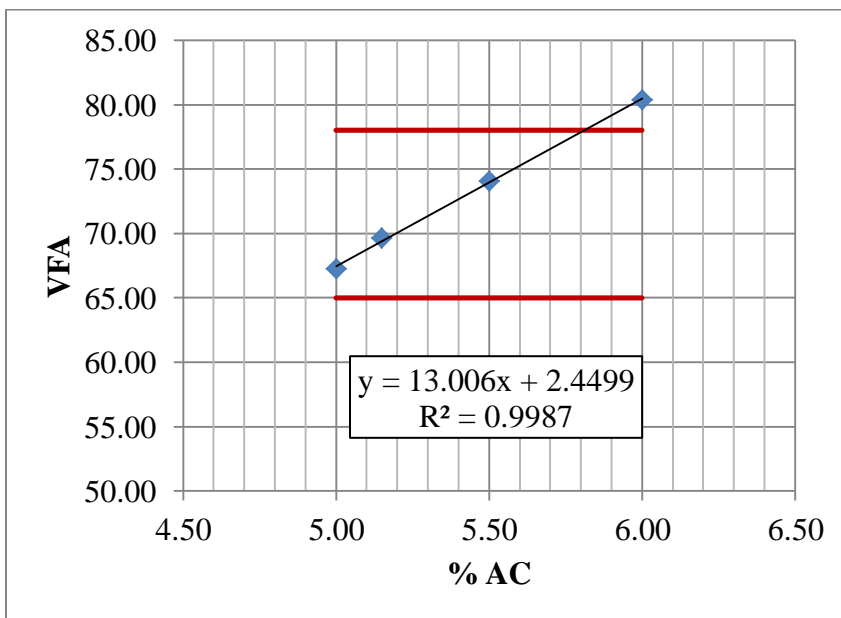

Figure 4.6: Percent VFA VS asphalt content

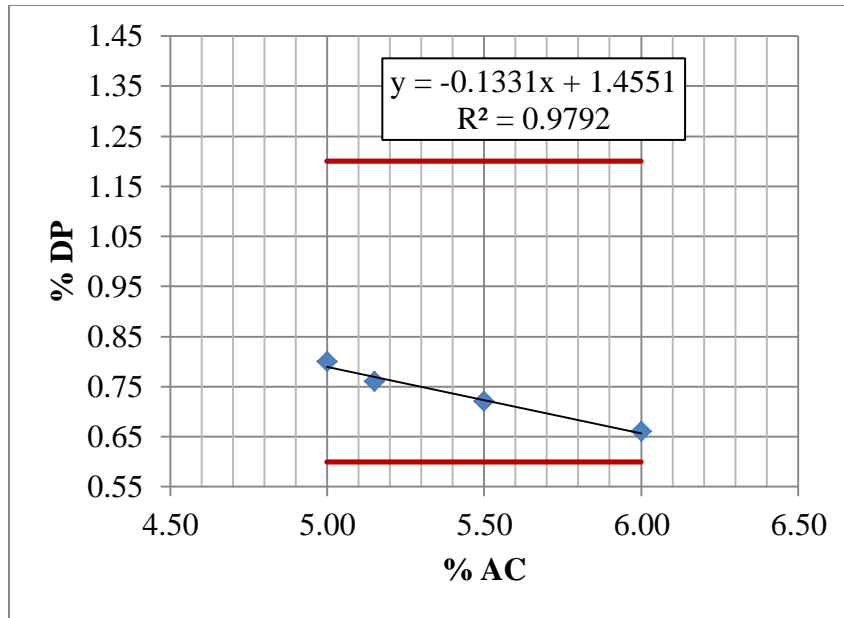

Figure 4.7: Percent DP VS asphalt content

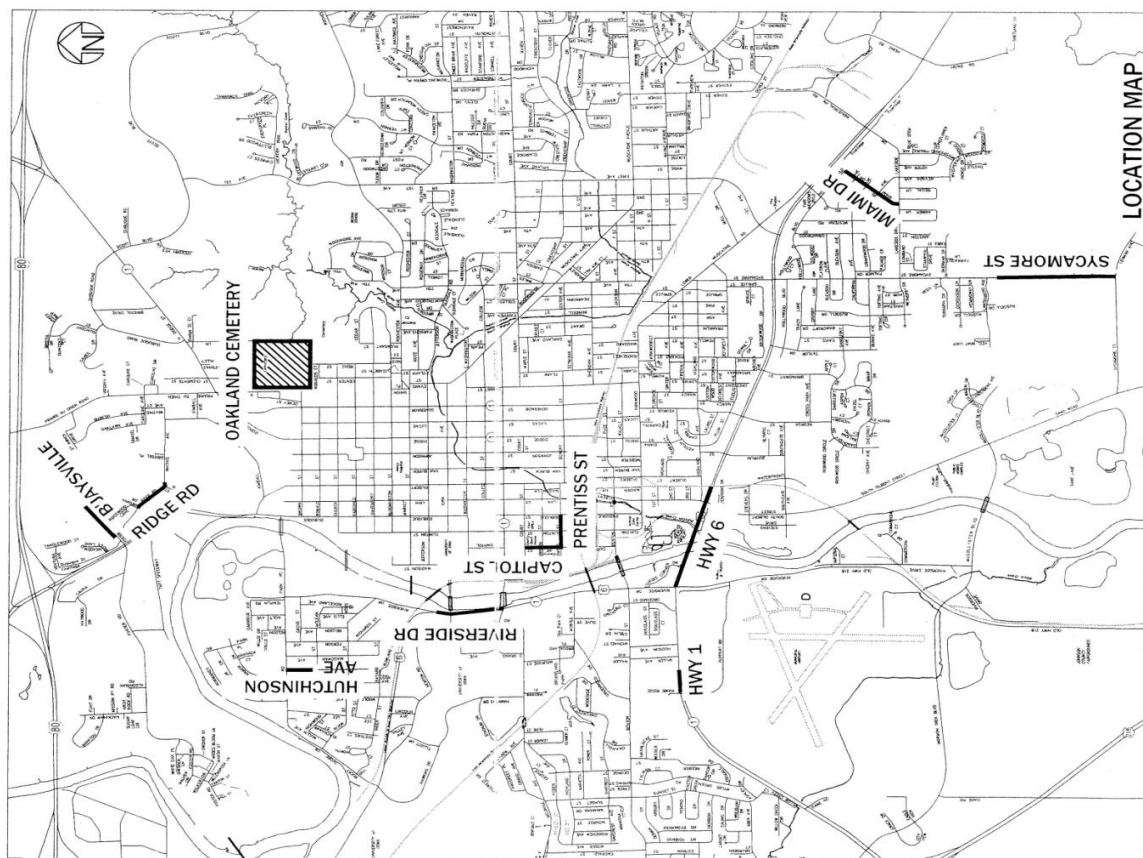

Figure 4.8: Pavement projects in Iowa City during the 2012 fiscal year

Mix Type	HMA	WMA
Binder Temperature (°C)	155	135
Aggregate Temperature (°C)	165	135
Loading Temperature (°C)	160	130
Paved Temperature (°C)	145	115
Compacted Temperature (°C)	135	110

Table 4.3: Field HMA and WMA temperatures



Figure 4.9: Capitol Street job site

Capitol Street (WMA)										
Sample	Thickness (mm)	Dry Weight	Wet Weight	SSD Weight	Field Density	Gmm	Air Voids	Avg. Field Voids	%Density	Avg. Field Density
1	1.6	714.4	389.1	715.6	2.188	2.461	11.09	8.97	92.596	94.808
2	1.75	819.8	468	820.1	2.328		5.39		98.532	
3	1.7	752.4	418.3	753.1	2.247		8.68		95.104	
4	1.5	660.3	366.8	660.9	2.245		8.77		95.013	
5	1.4	585.2	323.6	586	2.230		9.38		94.379	
6	1.6	703.5	391.2	704.1	2.248		8.64		95.147	
7	1.45	629.5	343.4	630.2	2.195		10.81		92.887	

Table 4.4: Field core data from Capitol Street



Figure 4.10: Miami Drive job site

Miami Drive (WMA)										
Sample	Thickness (mm)	Dry Weight	Wet Weight	SSD Weight	Field Density	Gmm	Air Voids	Avg. Field Voids	%Density	Avg. Field Density
1	1.75	824.3	467.8	824.6	2.310	2.476	6.69	7.01	97.644	97.313
2	1.625	759.7	430.3	760.2	2.303		6.99		97.330	
3	1.5	726.7	415.5	727	2.333		5.78		98.601	
4	1.5	721.3	404	721.7	2.270		8.30		95.959	
5	1.5	740.6	419.8	740.9	2.306		6.85		97.483	
6	1.375	629.9	353.6	630.1	2.278		7.99		96.286	
7	1.5	672.8	382.5	673	2.316		6.46		97.887	

Table 4.5: Field core data from Miami Drive

Mixture	Spec	HMA	WMA
Linear Feet	NA	1,205	670
Width	NA	25	50
Base Course (tons)	NA	276	308
Surface Course (tons)	NA	335	327
Design Binder Content (%)	NA	5.5	5.5
New Binder Content (%)	NA	4.60	4.60
Binder Content From RAP (%)	NA	11.01	11.01
Actual Binder Content (%)	NA	5.17	5.17
Effective Binder Content (%)	NA	4.62	4.88
Additive Content (%)	NA	0.0	0.069
Gmb	NA	2.366	2.363
Gmm	NA	2.476	2.461
Film Thickness	8.0-15.0	8.9	9.7
VMA (%)	14.7-15.7	14.9	15
Filler Binder Ratio	0.6-1.4	0.91	0.84
Air Voids (%) of Field Samples	3.5-4.5	4.4	4.0
Average Field Density of Cores	NA	2.602	2.240
Average Field Voids (%) of Cores	NA	7.01	8.97
Average % Density of Cores	NA	97.307	94.801

Table 4.6: Direct comparison of job sites

Mix type	Spec ID	Dry Weight	Wet Weight	SSD	Height (mm)	Width (mm)	Gmb	Gmm	Voids	Sat wt	Saturation
Field HMA Cond	FH1	1148.5	650.4	1151.2	65.11	100	2.293	2.476	7.08%	1176	77.59%
	FH2	1147.8	650.5	1149.8	65.09	100	2.299	2.476	6.86%	1174.7	78.59%
	FH3	1146.2	648.9	1148.4	65.07	100	2.295	2.476	7.02%	1174.1	79.54%
	FH4	1149	651.9	1151	65.15	100	2.302	2.476	6.72%	1175.3	78.41%
Field HMA Uncond	FH5	1147.5	650	1149.9	65.13	100	2.295	2.476	6.99%	X	
	FH6	1147.9	650.8	1149.8	65.18	100	2.300	2.476	6.79%	X	
	FH7	1147.9	650.2	1150.2	65.14	100	2.296	2.476	6.98%	X	
	FH8	1148.5	650.2	1150.9	65.11	100	2.294	2.476	7.06%	X	
Field WMA Cond	FW1	1179.2	669.9	1182.7	67.01	100	2.300	2.461	6.56%	1206.5	78.42%
	FW2	1181.1	672.1	1184.3	66.92	100	2.306	2.461	6.30%	1205.4	72.67%
	FW3	1180.5	672.3	1185.9	66.84	100	2.298	2.461	6.60%	1205.6	71.54%
	FW4	1180.7	673.5	1185.4	66.89	100	2.307	2.461	6.28%	1204.5	74.37%
Field WMA Uncond	FW5	1181.2	669.2	1184.9	66.90	100	2.290	2.461	6.93%	X	
	FW6	1181	670.8	1183.8	66.87	100	2.302	2.461	6.45%	X	
	FW7	1180.1	671.5	1183.3	66.80	100	2.306	2.461	6.31%	X	
	FW8	1178.7	669.4	1182.4	66.85	100	2.298	2.461	6.64%	X	

Table 4.7: Volumetric information of specimens used for Modified Lottman Testing

Case	Sample ID	P, lb	Avg.D, in	Avg.H, mm	Avg.H, in	S _t	Avg.S _t , PSI	TSR	95% Confidence
Wet Set	FH1	2437.0	4	65.11	2.56	153.81	156.48	76.22	6.69
	FH2	2432.0	4	65.09	2.56	153.54			
	FH3	2406.0	4	65.07	2.56	151.94			
	FH4	2642.0	4	65.15	2.56	166.64			
Dry Set	FH5	3081.0	4	65.13	2.56	194.39	205.29	76.22	9.90
	FH6	3421.0	4	65.18	2.57	215.68			
	FH7	3358.0	4	65.14	2.56	211.85			
	FH8	3157.0	4	65.11	2.56	199.26			

Table 4.8: Indirect tensile strength of field mixed HMA specimens

Case	Sample ID	P, lb	Avg.D, in	Avg.H, mm	Avg.H, in	S _t	Avg.S _t , PSI	TSR	95% Confidence
Wet Set	FW1	1808	4	67.01	2.64	110.87	113.22	74.94	2.55
	FW2	1818	4	66.92	2.63	111.63			
	FW3	1898	4	66.84	2.63	116.69			
	FW4	1880	4	66.89	2.63	113.68			
Dry Set	FW5	2421	4	66.90	2.63	148.71	151.09	74.94	3.25
	FW6	2507	4	66.87	2.63	154.07			
	FW7	2500	4	66.80	2.63	153.80			
	FW8	2404	4	66.85	2.63	147.77			

Table 4.9: Indirect tensile strength of field mixed WMA specimens

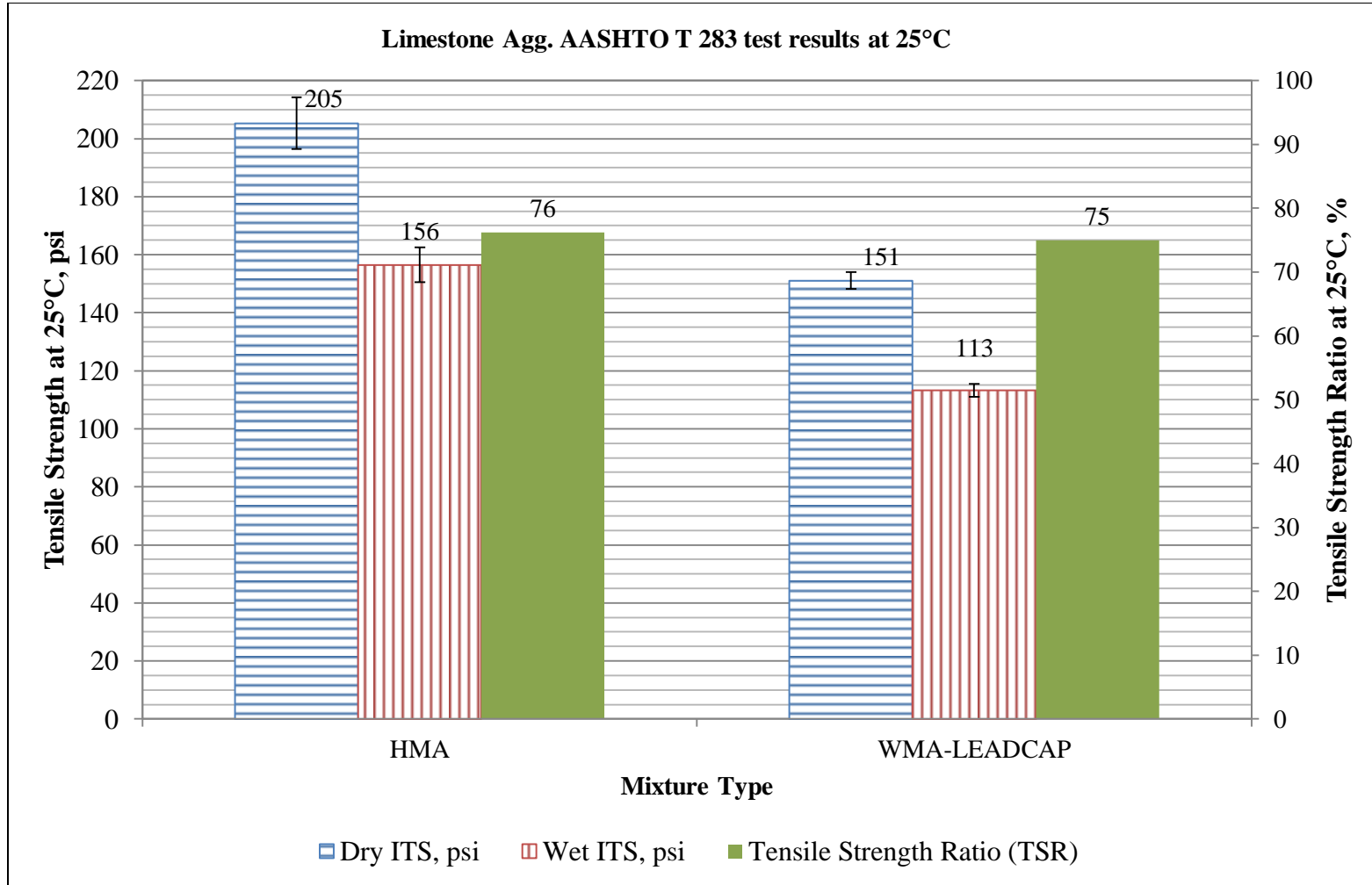

Figure 4.11: Indirect tensile strength and TSR of field mixed HMA and WMA specimens



Figure 4.12: Stripping effects on field mixed HMA specimens

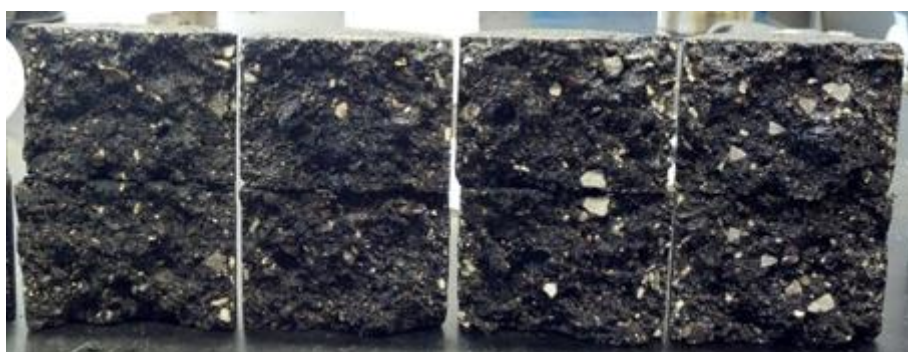

Figure 4.13: Stripping effects on field mixed WMA specimens

Mixture	Field Mixed HMA					
Test ID	FH1		FH2		FH3	
Specimen ID	FH1	FH2	FH3	FH4	FH5	FH6
Gmb	2.301	2.299	2.293	2.304	2.294	2.294
Gmm	2.476	2.476	2.476	2.476	2.476	2.476
Percent Air Voids	7.07	7.15	7.39	6.95	7.35	7.35
Average Air Voids	7.11		7.17		7.35	
Location in WT	Rear	Front	Rear	Front	Rear	Front
Wheel Passes to 10 mm Rut Depth	10,426		11,000		11,900	
Failed Core		X	X		X	
Average Depth @ 10 mm	-6.34	-8.60	-7.79	-9.06	-7.75	-7.43
Wheel Passes to Failure	15,624		15,201		17,932	
Failed Core		X		X		X
Max Depth @ Failure	-18.63	-20.03	-18.98	-20.08	-19.59	-20.01
Data Point for Max Depth	6	9	6	10	6	7
Average Depth @ Failure	-13.75	-18.88	-12.43	-18.87	-14.93	-16.14
Creep Slope	-0.0005		-0.0007		-0.0006	
Stripping Slope	-0.0022		-0.0027		-0.0017	
SIP	9,531		10,729		10,900	

Table 4.10: Field mixed HMA Hamburg test data

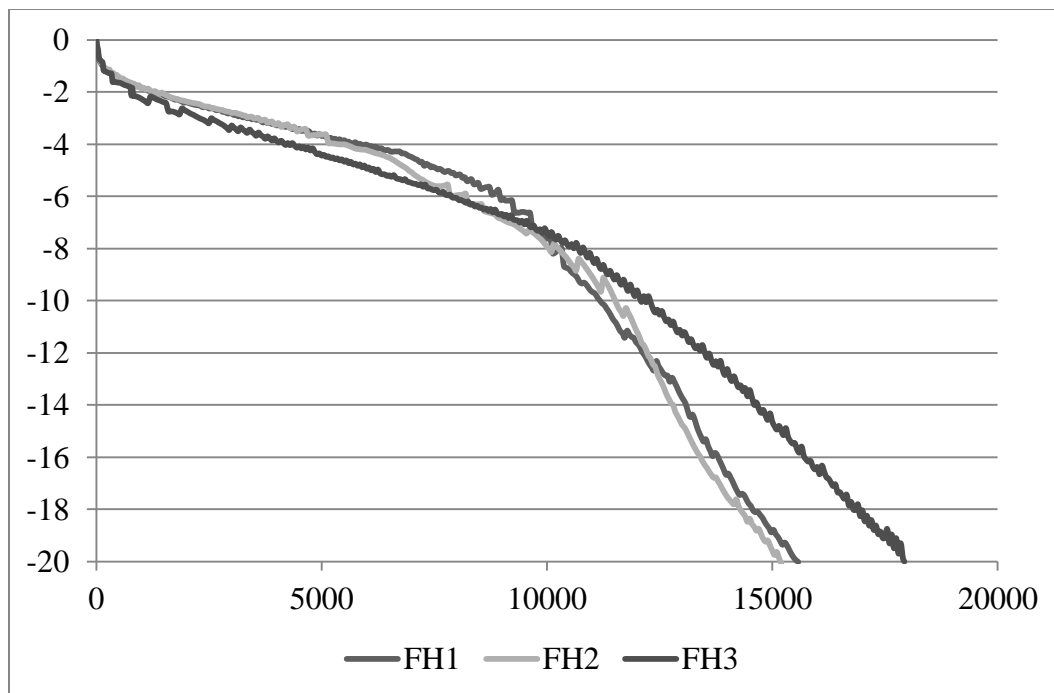

Figure 4.14: Field mixed HMA rut depth VS wheel passes

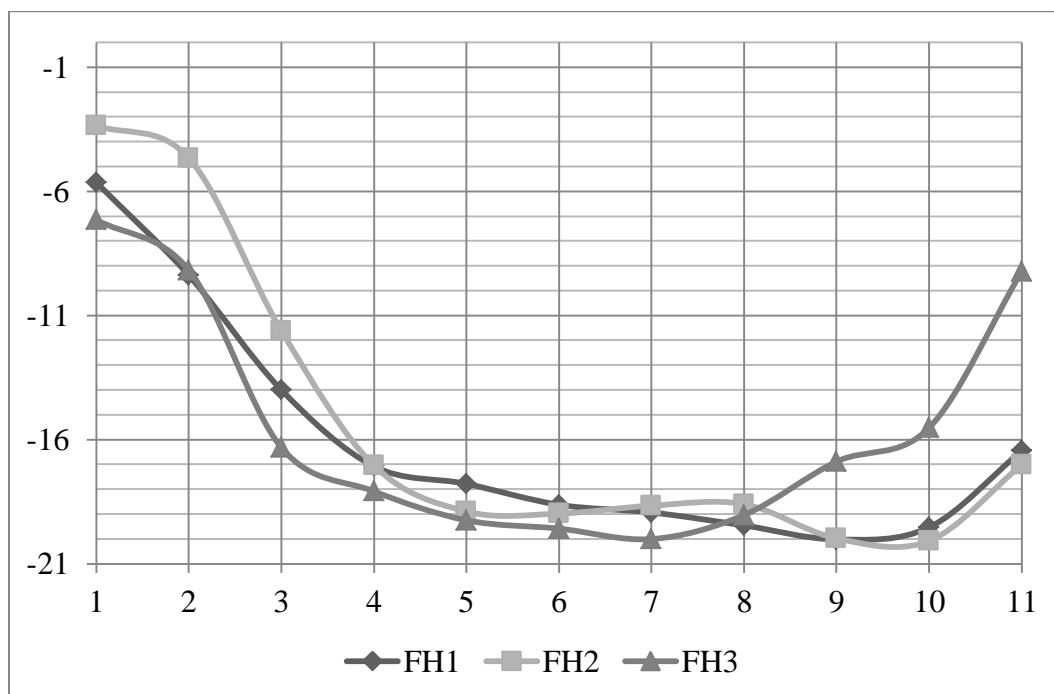

Figure 4.15: Field mixed HMA rut profile



Figure 4.16: Test FH2 specimens before testing (top)



Figure 4.17: Test FH2 specimens before testing (side)



Figure 4.18: Test FH2 specimens after testing (top)



Figure 4.19: Test FH2 specimens after testing (side)

Mixture	Field Mixed WMA					
Test ID	FW1		FW2		FW3	
Specimen ID	FW1	FW2	FW3	FW4	FW5	FW6
Gmb	2.295	2.301	2.288	2.285	2.287	2.297
Gmm	2.461	2.461	2.461	2.461	2.461	2.461
Percent Air Voids	6.75	6.50	7.03	7.15	7.07	6.66
Average Air Voids	6.62		7.09		6.87	
Location in WT	Rear	Front	Rear	Front	Rear	Front
Wheel Passes to 10 mm Rut Depth	6,150		5,750		6,550	
Failed Core		X		X	X	
Average Depth @ 10 mm	-6.47	-9.54	-7.29	-8.97	-7.71	-8.59
Wheel Passes to Failure	8,224		8,850		9,206	
Failed Core		X		X	X	
Max Depth @ Failure	-18.98	-20.03	-19.07	-19.96	-20.08	-19.73
Data Point for Max Depth	6	7	6	8	6	7
Average Depth @ Failure	-11.87	-17.00	-13.54	-16.49	-13.43	-16.68
Creep Slope	-0.0008		-0.0011		-0.0011	
Stripping Slope	-0.0045		-0.0034		-0.0038	
SIP	5,090		5,604		6,379	

Table 4.11: Field mixed WMA Hamburg test data

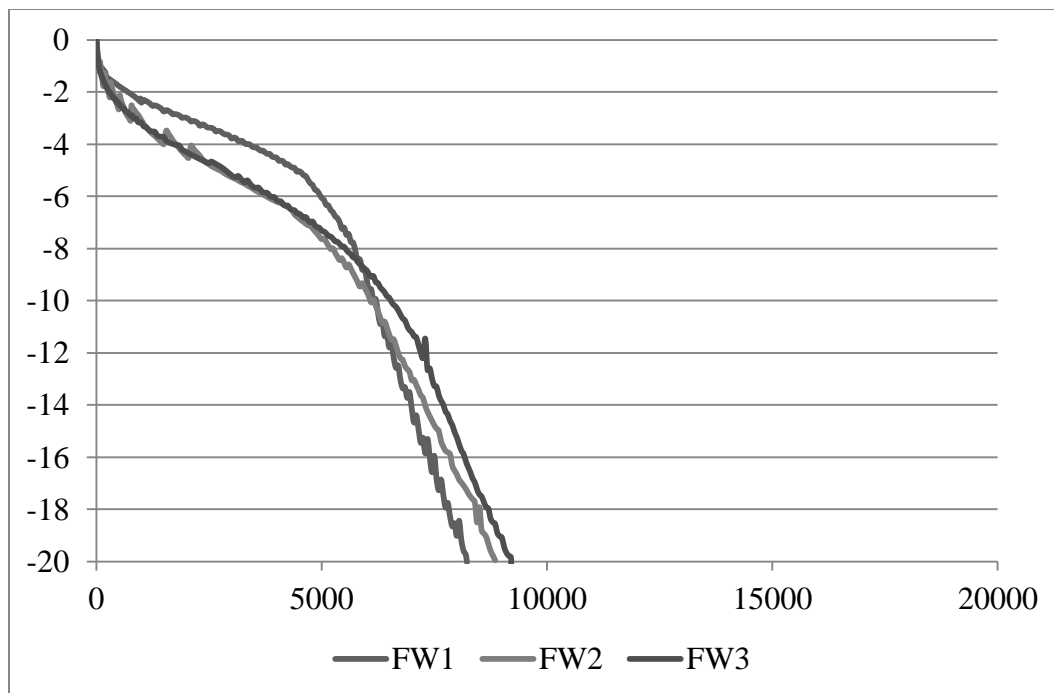

Figure 4.20: Field mixed WMA rut depth VS wheel passes

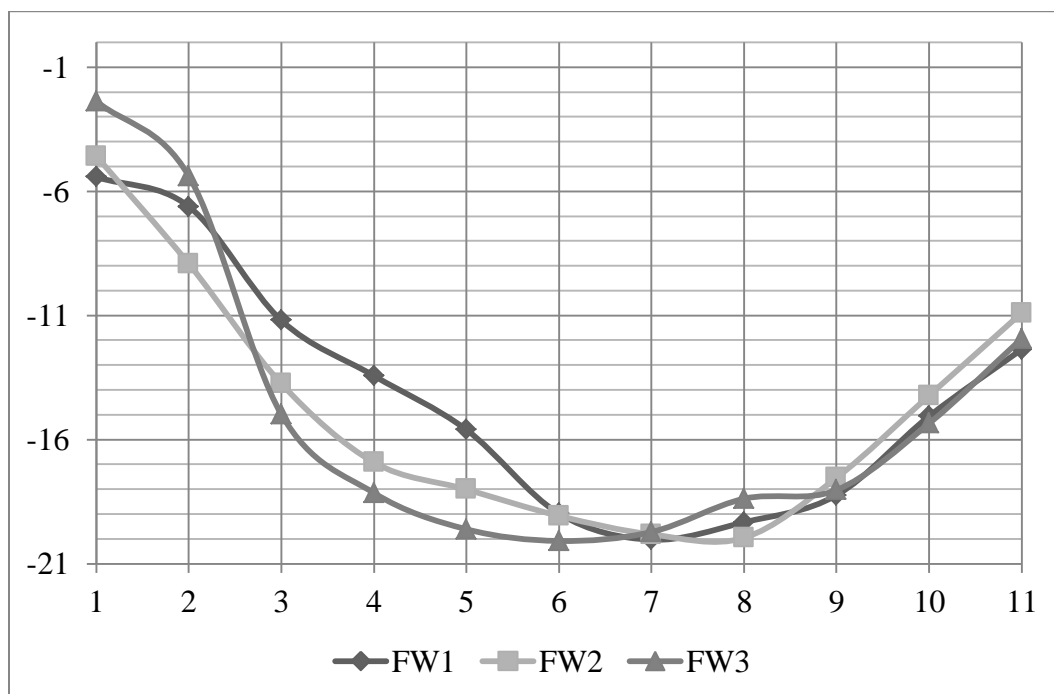

Figure 4.21: Field mixed WMA rut profile



Figure 4.22: Test FW2 specimens before testing (top)



Figure 4.23: Test FW2 specimens before testing (side)

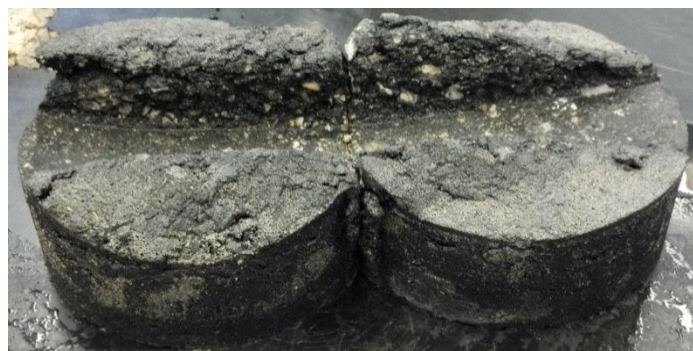

Figure 4.24: Test FW2 specimens after testing (top)



Figure 4.25: Test FW2 specimens after testing (side)

Mixture	Field Mixed Aged HMA					
Test ID	FHA1		FHA2		FHA3	
Specimen ID	FHA1	FHA2	FHA3	FHA4	FHA5	FHA6
Gmb	2.309	2.299	2.308	2.306	2.311	2.299
Gmm	2.476	2.476	2.476	2.476	2.476	2.476
Percent Air Voids	6.74	7.15	6.79	6.87	6.66	7.15
Average Air Voids	6.95		6.79		6.91	
Location in WT	Rear	Front	Rear	Front	Rear	Front
Wheel Passes to 10 mm Rut Depth	15,400		17,600		16,650	
Failed Core		X	X		X	
Average Depth @ 10 mm	-7.55	-7.50	-8.316	-8.893	-7.65	-8.47
Wheel Passes to Failure	DNF		DNF		DNF	
Failed Core						
Max Depth @ Failure	-13.02	-14.36	-14.11	-13.98	-12.81	-11.9
Data Point for Max Depth	6	7	6	7	4	10
Average Depth @ Failure	-10.09	-10.95	-10.59	-12.55	-9.82	-11.66
Creep Slope	-0.0005		-0.0003		-0.0003	
Stripping Slope	-0.0009		-0.0013		-0.0008	
SIP	10,922		14,449		11,376	

Table 4.12: Aged field mixed HMA Hamburg test data

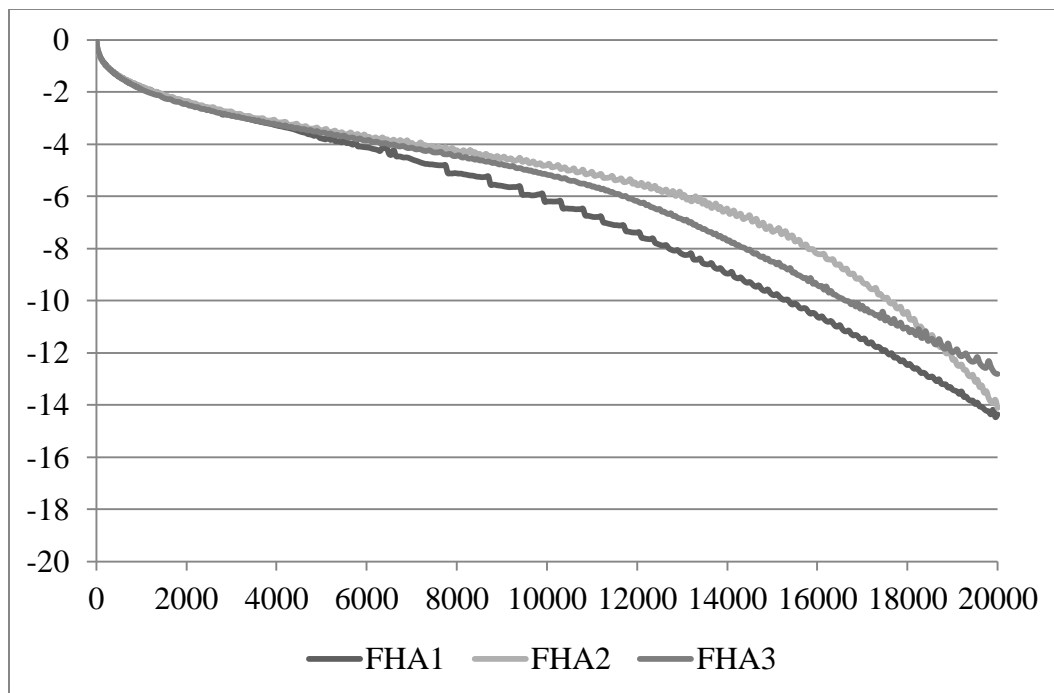

Figure 4.26: Aged field mixed HMA rut depth VS wheel passes

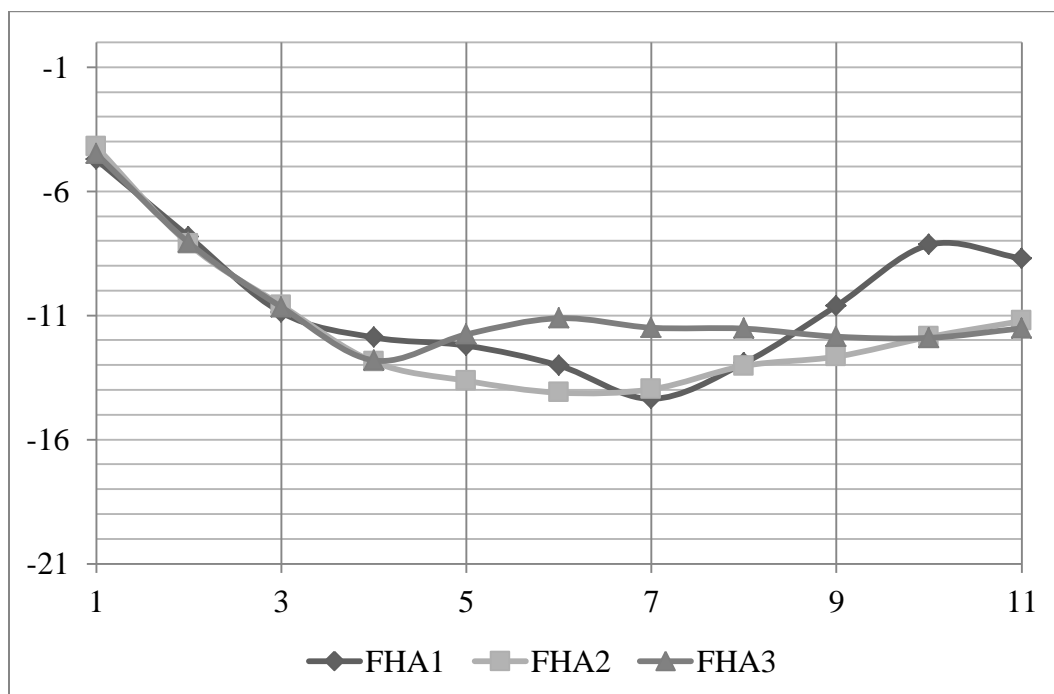

Figure 4.27: Aged field mixed HMA rut profile



Figure 4.28: Test FHA1 specimens before testing (top)



Figure 4.29: Test FHA1 specimens before testing (side)



Figure 4.30: Test FHA1 specimens after testing (top)



Figure 4.31: Test FHA1 specimens after testing (side)

Mixture	Field Mixed Aged WMA					
Test ID	FWA1		FWA2		FWA3	
Specimen ID	FWA1	FWA2	FWA3	FWA4	FWA5	FWA6
Gmb	2.279	2.285	2.285	2.280	2.290	2.283
Gmm	2.461	2.461	2.461	2.461	2.461	2.461
Percent Air Voids	7.40	7.15	7.15	7.35	6.95	7.23
Average Air Voids	7.27		7.15		7.09	
Location in WT	Rear	Front	Rear	Front	Rear	Front
Wheel Passes to 10 mm Rut Depth	6,500		9,250		7,950	
Failed Core		X		X		X
Average Depth @ 10 mm	-5.882	-9.038	-7.372	-8.709	-6.640	-8.060
Wheel Passes to Failure	10,056		13,917		12,516	
Failed Core		X		X		X
Max Depth @ Failure	-14.22	-20.08	-19.29	-20.03	-15.97	-20.05
Data Point for Max Depth	6	9	6	7	6	9
Average Depth @ Failure	-9.369	-17.54	-12.55	-16.08	-11.14	-18.09
Creep Slope	-0.0009		-0.0007		-0.0006	
Stripping Slope	-0.0028		-0.0024		-0.0035	
SIP	5,612		9,947		9,202	

Table 4.13: Aged field mixed WMA Hamburg test data

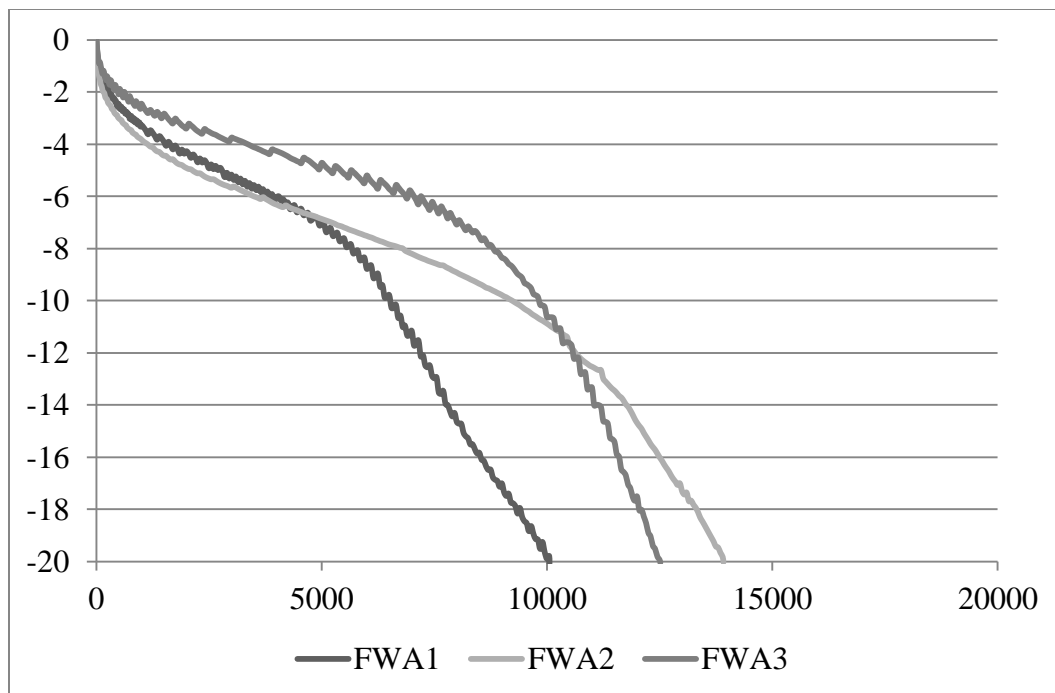

Figure 4.32: Aged field mixed WMA rut depth VS wheel passes

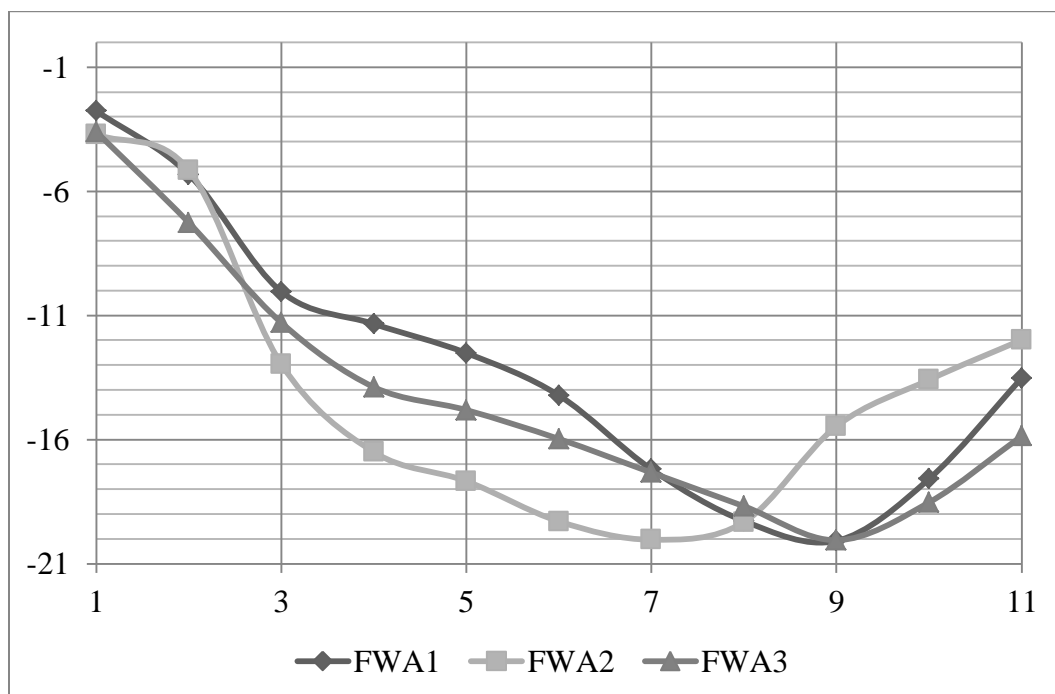

Figure 4.33: Aged field mixed WMA rut profile



Figure 4.34: Test FWA3 specimens before testing (top)



Figure 4.35: Test FWA3 specimens before testing (side)



Figure 4.36: Test FWA3 specimens after testing (top)



Figure 4.37: Test FWA3 specimens after testing (side)

Mixture	Field HMA	Aged Field HMA	Field WMA	Aged Field WMA
Average Voids	7.21	6.88	6.86	7.17
Average Passes to Failure	16,252	26,834	8,760	12,163
Average Creep Slope	-0.0006	-0.00036	-0.001	-0.00073
Average Stripping Slope	-0.00022	-0.0001	-0.0039	-0.0029
Average SIP	10,387	12,249	5,691	8,253

Table 4.14: Summary of data collected during Hamburg Wheel Tracking Tests

CHAPTER 5

COMPARISON OF PERFORMANCE TEST RESULTS

In order to determine the effects of the selected WMA additive the results of the Modified Lottman and Hamburg Wheel Tracking Test were compared. Since the mixtures obtained from the field may differ in aggregate gradation and binder content they should not be directly compared with the laboratory mixtures

5.1 Modified Lottman Test Data

The Modified Lottman test was performed on both lab and field mixtures and test results are summarized in Table 5.1. As can be seen from Table 5.1, the TSR values of the lab mixed HMA and WMA varied more than those of the field mixed HMA and WMA. A close up look at the stripping experienced by the lab mixed HMA and WMA are shown in Figures 5.1 and 5.2, respectively. As can be seen from Figures 5.1 and 5.2, the stripping on the lab mixed WMA specimen is more pronounced than those of lab mixed HMA. Since both mixtures experienced a good amount of stripping it could be postulated that the aggregate chosen for the lab mixtures was hydrophilic, meaning that the aggregate is slightly acidic and prefers water molecules to asphalt molecules. This is unlikely however as limestone aggregates are typically resistant to stripping (16). As is the case with many properties of aggregate surface chemistry, specific cause-effect relationships have yet to be established making it difficult to determine what properties specifically effect stripping.

Another interesting finding from the Modified Lottman tests was the dry indirect tensile strengths (ITS). Strength of asphalt mixtures is strongly tied to the particle shape of the aggregate. Rounded particles will decrease the particle-to-particle interlock which

will reduce the strength of asphalt mixtures. The lab mixtures exhibited a smaller ITS value than the field mixtures suggesting that the angularity of the aggregate was less than the aggregate used in the field mixtures. The ITS values of the lab mixtures were more consistent than the field mixtures because that the gradation of the lab mixed HMA and WMA were more consistent than field mixtures. A significant difference in the ITS values of the field mixed HMA and WMA suggest that there might be more variation in the aggregate gradation and binder content. This is to be expected because the lab mixed specimens had a controlled gradation whereas the gradation of field mixed specimens would be varied.

5.2 Hamburg Wheel Tracking Test Data

Tables 5.2 and 5.3 summarized the average passes to failure (a), average creep slope (b), average stripping slope (c) and average SIP (d) of lab and field mixtures, respectively.

5.2.1 Lab Mixed Data

As was mentioned earlier, the HMA mixture with PG 64-22 performed the better than others, reaching 10,273 passes which is 15% more than the HMA with PG 58-28, 66% more than the WMA with PG 58-28 modified with 1.5% additive and 53% more than the WMA with PG 64-22 modified with 1.0% additive. The WMA with PG 64-22 modified with 1.0% additive reached 7,758 passes, 9% more than the WMA with PG 58-28 modified with 1.5% additive.

Based on the creep slopes of the lab mixtures, the HMA mixture with PG 58-28 performed better than the others. The average creep slope of this mixture was -0.00083, 61% of the WMA with PG 58-28 modified with 1.5% additive, 78% of the HMA with

PG 64-22 and 46% of the WMA with PG 64-22 modified with 1.0% additive. It was unexpected to find that the HMA with PG 64-22 was less resistant to rutting than the HMA with PG 58-28. The increased stiffness of the PG 64-22 should have resulted in a slightly better creep slope. Again, the ratio of the two HMA mixtures is very similar to that of the two WMA mixtures, 61% to 59%, strengthening the argument that the extra additive did not contribute significantly.

Based on the stripping slopes of the lab mixtures, the HMA mixture with PG 58-28 binder performed better than the others. The average stripping slope of the mixture was -0.001967, 97% of the HMA with PG 58-22 binder, 63% of the WMA with PG 58-28 binder modified with 1.5% additive and 76% of the WMA with PG 64-22 binder modified with 1.0% additive. The ratio of the two HMA mixtures, 97%, was higher this time than the two WMA mixtures, 84%, but a decreased additive content should not have increased resistance to moisture damage meaning that it was likely due to the binder.

The stripping inflection point of the mixtures can be hard to determine with accuracy especially on mixtures that have a poor creep slope or a small stripping inflection point. The HMA with PG 64-22 had the highest stripping inflection point meaning that it reached more passes until moisture damage began to occur than the other mixtures. It reached 147% more than the HMA with PG 58-28, 137% more than the WMA with PG 58-28 modified with 1.5% additive and 88% more than the WMA with PG 64-22 modified with 1.0% additive. The ratios are reversed in this case when comparing the two HMA and two WMA specimens. The WMA with PG 58-28 modified with 1.5% additive lasted longer before moisture damage occurred than the HMA with PG 58-28 binder. It is unknown exactly what caused this to happen.

5.2.2 Field Mixed Data

As was mentioned earlier, the aged field HMA mixture performed better than the others in all categories. It reached 26,834 passes which is 65% more than the field HMA, 206% more than the field WMA and 121% more than the aged field WMA. When comparing the HMA and WMA ratios, it can be seen that both mixtures aged at roughly the same rate when looking at average passes to failure. The aged HMA was able to reach 65% more passes than the field HMA and the aged field WMA was able to reach 70% more passes than the field WMA.

Based on the creep slopes gathered from the field data the aged field HMA proved to be superior to the other mixtures with a value of -0.00036. This is 60% of the field HMA, 36% of the field WMA, and 49% of the aged field WMA. When comparing the aging of the HMA and WMA it can be seen again that both mixtures aged at roughly the same rate. The aged field HMA had a creep slope that was 60% of the field HMA while the aged field WMA had a creep slope that was 73% of the field WMA.

Based on the stripping slopes gathered from the field data the aged field HMA proved to be superior to the other mixtures with a value of -0.001. This is 45% of the field HMA, 26% of the field WMA and 34% of the aged field WMA. The aging of the mixtures seemed to be slightly off here as the aged field HMA had a stripping slope that was 45% of the field HMA while the aged field HMA had a stripping slope that was 74% of the field WMA. It is unknown what would cause such a difference in ratios.

The stripping inflection point of the field samples was much easier to calculate than those of the lab mixtures. This is mainly due to a better resistance to rutting and a higher average passes to failure. Like all other categories the aged field HMA had the

best stripping inflection point at 12,249. This was 18% more than the field HMA, 83% more than the field WMA and 48% more than the aged field WMA. When comparing the HMA ratios and the WMA ratios it can be observed that, like in most cases, the mixtures aged at roughly the same pace. The aged field HMA survived 18% more passes than the field HMA and the aged field WMA survived 23% more passes than the field WMA.

Mixture	Compaction Temp, °C	Short-term aging	Average Air Voids	Dry ITS, psi	Wet ITS, psi	TSR
Lab HMA	135	4 hrs at 135°C	7.05%	140	76	54
Lab WMA	115	16 hrs at 60°C + 1 hr at 125°C + 2 hrs at 115° C	7.13%	136	38	28
Field HMA	135	4 hrs at 135°C	6.94%	205	156	76
Field WMA	115	16 hrs at 60°C + 1 hr at 125°C + 2 hrs at 115° C	6.74%	151	113	75

Table 5.1: Comparison of Modified Lottman test results

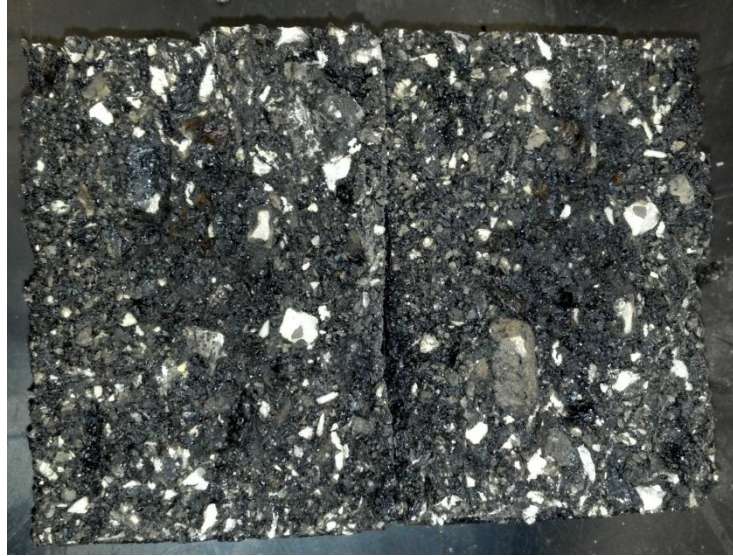

Figure 5.1: Stripping on a lab mixed HMA specimen



Figure 5.2: Stripping on a lab mixed WMA specimen

Mixture		HMA 58-28	WMA 58-28 + 1.5% Additive	HMA 64-22	WMA 64-22 + 1.0% Additive
	Average Passes to Failure	10,273	7,140	11,831	7,758
HMA 58-28	10,273		70%	115%	76%
WMA 58-28 + 1.5% Additive	7,140	144%		166%	109%
HMA 64-22	11,831	87%	60%		66%
WMA 64-22 + 1.0% Additive	7,758	132%	92%	153%	

Table 5.2: Comparison of passes to failure of laboratory mixed specimens

Mixture		HMA 58-28	WMA 58-28 + 1.5% Additive	HMA 64-22	WMA 64-22 + 1.0% Additive
	Average Creep Slope	-0.00083	-0.00136	-0.00106	-0.0018
HMA 58-28	-0.00083		164%	128%	217%
WMA 58-28 + 1.5% Additive	-0.00136	61%		78%	132%
HMA 64-22	-0.00106	78%	128%		170%
WMA 64-22 + 1.0% Additive	-0.0018	46%	76%	59%	

Table 5.3: Comparison of creep slopes of laboratory mixed specimens

Mixture		HMA 58-28	WMA 58-28 + 1.5% Additive	HMA 64-22	WMA 64-22 + 1.0% Additive
	Average Stripping Slope	-0.00203	-0.0031	-0.001967	-0.0026
HMA 58-28	-0.00203		153%	97%	128%
WMA 58-28 + 1.5% Additive	-0.0031	65%		63%	84%
HMA 64-22	-0.001967	103%	158%		132%
WMA 64-22 + 1.0% Additive	-0.0026	78%	119%	76%	

Table 5.4: Comparison of stripping slopes of laboratory mixed specimens

Mixture		HMA 58-28	WMA 58-28 + 1.5% Additive	HMA 64-22	WMA 64-22 + 1.0% Additive
	Average SIP	1,639	1,704	4,044	2,156
HMA 58-28	1,639		104%	247%	132%
WMA 58-28 + 1.5% Additive	1,704	96%		237%	127%
HMA 64-22	4,044	41%	42%		53%
WMA 64-22 + 1.0% Additive	2,156	76%	79%	188%	

Table 5.5: Comparison of stripping inflection points of laboratory mixed specimens

Mixture		HMA Field	WMA Field	HMA Field Aged	WMA Field Aged
	Average Passes to Failure	16,252	8,760	26,834	12,163
HMA Field	16,252		54%	165%	75%
WMA Field	8,760	186%		306%	139%
HMA Field Aged	26,834	61%	33%		45%
WMA Field Aged	12,163	134%	72%	221%	

Table 5.6: Comparison of passes to failure of field mixed specimens

Mixture		HMA Field	WMA Field	HMA Field Aged	WMA Field Aged
	Average Creep Slope	-0.0006	-0.001	-0.00036	-0.00073
HMA Field	-0.0006		167%	60%	122%
WMA Field	-0.001	60%		36%	73%
HMA Field Aged	-0.00036	167%	278%		203%
WMA Field Aged	-0.00073	82%	137%	49%	

Table 5.7: Comparison of creep slopes of field mixed specimens

Mixture		HMA Field	WMA Field	HMA Field Aged	WMA Field Aged
	Average Stripping Slope	-0.0022	-0.0039	-0.001	-0.0029
HMA Field	-0.0022		177%	45%	132%
WMA Field	-0.0039	56%		26%	74%
HMA Field Aged	-0.001	220%	390%		290%
WMA Field Aged	-0.0029	76%	134%	34%	

Table 5.8: Comparison of stripping slopes of field mixed specimens

Mixture		HMA Field	WMA Field	HMA Field Aged	WMA Field Aged
	Average SIP	10,386	6,691	12,249	8,253
HMA Field	10,386		64%	118%	79%
WMA Field	6,691	155%		183%	123%
HMA Field Aged	12,249	85%	55%		67%
WMA Field Aged	8,253	126%	81%	148%	

Table 5.9: Comparison of stripping inflection points of field mixed specimens

CHAPTER 6

SUMMARY AND CONCLUSIONS

The main objectives of this study were to: 1) perform a mix design and Hamburg Wheel Tracking test of additive modified mixtures, 2) construct a pavement using the additive modified mixtures in Iowa and 3) compare the physical and volumetric properties of lab and field mixed pavements.

To determine the optimum asphalt content, a Superpave mixture design for an HMA mixture using Iowa aggregates was performed using a PG 58-28 and PG 64-22 binder. The resulting optimum asphalt content for both the mixtures was 5.00%. The same asphalt content was used for the WMA mixtures because asphalt absorption was measured at less than 1.00%. The Hamburg Wheel Tracking Test and Modified Lottman Test were then performed on the laboratory WMA and HMA mixtures with the optimum asphalt content and 7.0 percent air voids. Field samples of both a WMA mixture modified with a wax based additive and HMA mixture were collected from two different job sites and they were subjected to the Hamburg Wheel Tracking Test and Modified Lottman Test.

Hamburg Wheel Tracking Test results of laboratory HMA and WMA mixtures exhibited that the HMA specimens using a PG 64-22 performed better than others in terms of number of passes to failure. The best creep slope was that of the laboratory HMA mixture with PG 58-28; 78% of the HMA mixture with PG 64-22, 61% of the WMA mixture with PG 58-28 modified with 1.5% additive and 46% of the WMA with PG 64-22 modified with 1.0% additive. The best stripping slope was that of the laboratory HMA mixture with PG 64-22; it was 97% of the HMA mixture with PG 58-

28, 76% of the WMA mixture with PG 64-22 modified with 1.5% additive and 63% of the WMA mixture with PG 58-28 modified with 1.5% additive.

The Hamburg Wheel Tracking Test was performed on field HMA and WMA mixtures. Overall, the aged field HMA specimens performed better than the field WMA specimens. The aged field HMA mixture had the best creep and stripping slope. The creep slope was 60% of the field HMA mixture, 49% of the aged field WMA mixture and 36% of the field WMA mixture. The stripping slope was 45% of the field HMA, 34% of the aged field WMA mixture and 26% of the field WMA mixture.

Based on limited Hamburg Wheel Tracking Test results, it can be concluded that HMA mixtures were more resistance to rutting and moisture damage than WMA mixtures using a wax based additive. Overall, field mixtures performed better than laboratory mixtures.

Based on Modified Lottman Test results of limited laboratory HMA and WMA mixtures, it can be concluded that the WMA specimens were more susceptible to moisture damage. Although they dry indirect tensile strength (ITS) of both the WMA and HMA specimens were similar, 136 psi and 140 psi respectively, the conditioned ITS's were significantly different, 38 psi and 76 psi respectively. This resulted in a TSR value of 28% for the WMA specimens and 54% for the HMA specimens, which are significantly lower than the Superpave criterion of 80%. Although the field WMA specimens had a lower dry and conditioned ITS, 151 psi and 113 psi respectively, than the HMA, 205 psi and 156 psi respectively, they both exhibited similar TSR values. The TSR value of the WMA specimens was 75% whereas the TSR value of the HMA specimens was 76%.

The first WMA pavement modified with the selected wax based additive in the United States of America was successfully constructed in Iowa City. The pavement using the wax based additive was produced and constructed in Iowa City by L.L. Pelling, who successfully added and properly blended the wax based additive with an asphalt binder. They successfully constructed a WMA pavement using asphalt with the wax based additive. The average air void of laboratory compacted field samples was 3.97% and the average air void of field cores was 9.0%. The mixing and compaction temperatures were significantly reduced by 25°C (45°F). Traffic was immediately allowed after construction. Given the successful application of WMA mixtures using the wax based additive in Iowa City, it is recommended that more WMA pavements should be constructed using asphalt binder that has been blended with the wax based additive.

APPENDIX A.
LABORATORY TESTING PROCEDURES

All the test procedures using which the experiments were run are explained in detail below.

Rice Specific Gravity Test

1. Weigh out approximately 2000 grams of asphalt mix and allow it to cool in a pan to a temperature of 25°C. Record the precise weight of the mix as *WHMA*. Using a spatula, chop up any large clumps of your mix, trying to get all of the coated aggregate specimens as separated as is possible in a few minutes time. Allow the mix to cool 20-30 minutes.
2. Fill the container until it is overflowing. Place the lid on and push it down firmly. Dry the outside of the container, and then measure its mass, *D*. Empty all but about $\frac{1}{4}$ of the water from the container.
3. Place the ~2000 grams of asphalt mix into container. The container should be about half full
4. Place the lid back onto the container and set it into the vibration harness and set the vibration level between 9 and 10. Pull a vacuum of 30 mmHg (using the dial on the gauge to keep it constant) on the contents for approximately 15 minutes. (Here, the objective is to remove trapped air from the submerged mix.).



Figure A1: Rice specific gravity test equipment

5. Fill the container to overflowing and press the lid down firmly. Dry the outside of the container and then re-weigh, E .
6. Compute the Rice specific gravity G_{mm} of the mix as follows:

$$G_{mm} = \frac{W_{HMA}}{D - E + W_{HMA}}$$

Equation A1: Specific Gravity (G_{mm})

Bulk Specific Gravity

1. The water bath was filled with the water at $25 \pm 1^\circ\text{C}$ ($77 \pm 1.8^\circ\text{F}$) and the water level was allowed to stabilize.
2. Three different weights as listed below were taken by utilizing the scale.
 - a. Weight in the air (W_a)

The weight of the dry sample was taken by simply using the scale.



Figure A2: Weight of the sample in dry condition

b. Weight in the water (W_w)

After taking the weight in the air, the sample was kept in the water bath for 2 ± 0.5 minutes and the weight was recorded to the nearest of 0.1 gram.

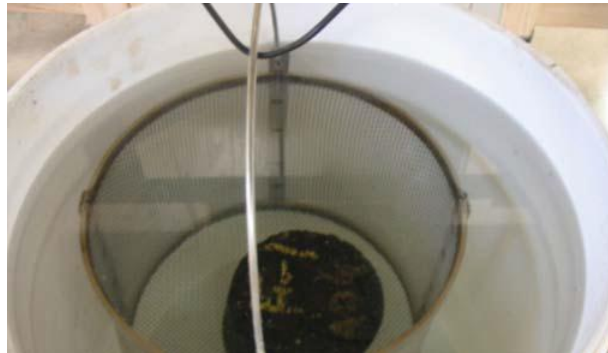

Figure A3: Weight of the sample in water

c. Weight after removing the surface water (W_{ssd})

The sample was then removed from the water bath and the surfaces of the samples were dried with the napkin. The balance was reset to zero and very quickly, the Surface Saturated Dry weight of the sample was recorded. Any water comes out

from the specimen during this time period was counted as a weight of the saturated specimen.

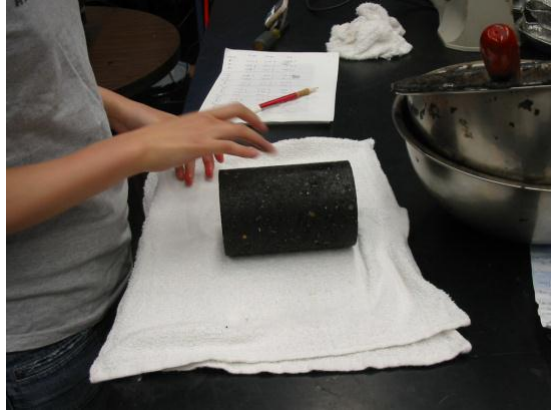

Figure A4: Surface saturation of the sample

With the knowledge of all three weights, the bulk specific gravity for all specimens was found using the following equation.

$$G_{mb} = \frac{\text{weight in air}}{\text{SSD weight} - \text{submerged weight}}$$

Equation A2: Bulk specific gravity (G_{mb})

Percentages of air voids present in the samples were found using the equation below.

$$\text{Air Voids} = 100 * \left(1 - \frac{G_{mb}}{G_{mm}}\right)$$

Equation A3: Air voids present in samples

Moisture Sensitivity Test

Preparation of Compacted Specimens

1. Ten samples were produced for each test, half to be tested dry and the other half to be tested after partial saturation and moisture conditioning with a freeze-thaw cycle. Two additional specimens for the set were prepared. These specimens can then be used to establish compaction procedures or the vacuum saturation technique.



Figure A5: Dry and wet set of specimens for moisture sensitivity test

2. Specimens 100mm in diameter by 65.0 ± 2.5 mm in height. The samples having height more or less than 65.0 ± 2.5 millimeter were not considered for the study and discarded.



Figure A6: Specimen after compaction

3. The mixtures were prepared in batches large enough to make at least 3 specimens. Alternatively, batch was prepared large enough to just make one specimens at a time. While preparing a multi-specimen batch, the batch was divided into single-specimen quantities before placing in the oven.
4. The mixture was placed in the pan having the bottom area approximately equal to 48,400 to 129,000 mm² and depth approximately equal to 25 millimeter. The mixture was allowed to cool at 2 ± 0.5 hours at the room temperature.
5. Then the mixture was placed in an oven for curing. WMA specimens were cured at $60 \pm 3^{\circ}\text{C}$ for 16 ± 0.5 hours for curing. HMA specimens were cured at $135 \pm 3^{\circ}\text{C}$ for 4 ± 0.5 hours for curing. The pans were placed on spacers to allow air circulation under it.
6. After curing, the mixture was placed in an oven for 2 hours \pm 10 minutes at the compaction temperature $\pm 3^{\circ}\text{C}$ prior to compaction. The mixture is compacted to 7 ± 0.5 percent air voids. The optimum number of gyrations was found necessary to achieve the air voids in the range of 6.5 to 7.5 %. The void range was obtained

by adjusting different number of gyrations for different products.

7. After the specimens are removed from the molds, they are stored at room temperature for 24 ± 3 hours.

Evaluating and Grouping of Compacted Specimens

After curing, the following tests and measurements of each specimen were conducted by following the methods explained before:

1. The maximum specific gravity (G_{mm}) was measured using the Rice Specific Gravity test.
2. The thickness (t) and diameter (D) was measured of each specimen.
3. The bulk specific gravity (G_{mb}) was measured in accordance with AASHTO – T 166. The volumes of the specimens were determined by subtracting the specimen weight in water from the saturated, surface-dry weight.
4. Once determined, the specimens are separated into two subsets, of at least three specimens each, so that the average air voids of the two subsets, for dry subset specimens and wet subset specimens, are approximately equal.
5. If the determined air void is found out of range from 6.5% to 7.5%, the specimen was discarded.

Reconditioning of Specimens

At the end of the curing period, the dry subset was wrapped with plastic in a heavy duty, leak proof plastic bag. The specimens were then placed in a $25 \pm 0.5^\circ\text{C}$ water bath for 2 hours \pm 10 minutes with a minimum of 25mm of water above their surface.



Figure A7: Reconditioning of the dry subset

The wet subset is conditioned as follows:

1. The specimens were placed in a vacuum container supported a minimum of 25mm above the container bottom.
2. The container is filled with potable water at room temperature so that the specimens have at least 25mm of water above their surface.
3. A vacuum of 250-660 mmHg partial pressure is applied for approximately 5 to 10 minutes depending upon vacuum system and level of air void.



Figure A8: Vacuum of a specimen

4. The vacuum is removed and the specimen is left submerged in water for approximately 5 to 10 minutes.
5. Measure the weight of the saturated and surface-dry specimen after partial vacuum saturation is done.
6. The degree of saturation level is determined by comparing the volume of absorbed water with the volume of air voids using the excel sheet.
7. If the degree of saturation is between 70 and 80 percent, the conditioning by freezing may continue. If the degree of saturation is less than 70 percent, the vacuum procedure using more vacuum and/or time is repeated. If the degree of saturation is more than 80 percent, the specimen is considered damaged and is discarded.
8. For specimens with 70 to 80 percent saturation, the specimens are each wrapped with a plastic film such as saran wrap and placed in a plastic bag containing 10 ± 0.5 ml of water and sealed. The plastic bags are placed in a freezer at a temperature of $-18 \pm 3^{\circ}\text{C}$ for 16 hours \pm 10 minutes.



Figure A9: Freezing of the wet specimens at -18°C for 16 hours

9. Remove the specimens from freezer. Place the specimens in a water bath at $60 \pm 1^\circ\text{C}$ for 24 ± 1 hours. The specimens should have a minimum of 25mm of water above their surface. As soon as the specimens are placed in the water bath, the plastic bag and film is removed from each specimen.



Figure A10: Specimens inside the water bath at 60°C for 24 hours

10. After 24 ± 1 hours in the water bath, the specimens are removed and placed in a water bath at $25 \pm 0.5^\circ\text{C}$ for 2 hours \pm 10 minutes. The specimens should have a minimum of 25 mm of water above their surface.
11. The specimen is removed from the bath, the thickness determined, and then placed on its side between the bearing plates of the testing machine. Steel loading strips are placed between the specimen and the bearing plates. A load is applied to the specimen by forcing the bearing plates together at a constant rate of 50 mm/minute.



Figure A11: Indirect Tensile Strength of a specimen

12. The maximum load is recorded, and the load continued until the specimen cracks. The machine is stopped and the specimen broken apart at the crack for observation.
13. The tensile strength is calculated using the following equation:

$$St = \frac{2P}{\pi * t * D}$$

Equation A4: Tensile Strength

Where:

St = tensile strength, psi

P = maximum load, lbs

t = specimen thickness, in.

D = specimen diameter, in.

14. The tensile strength ratio is calculated as follows:

$$\text{Tensile Strength Ratio (TSR)} = S_1/S_2$$

Equation A5: Tensile Strength Ratio

Where:

S_1 = average tensile strength of the wet subset, psi

S_2 = average tensile strength of the dry subset, psi

Hamburg Wheel Tracker Test

Preparation of Compacted Specimens

1. Six to ten samples were produced for each testing group. Each test required two samples to complete so the amount of tests completed is equal to half of the samples produced.
2. Specimens 150mm in diameter by 70.0 ± 2.5 mm or 60.0 ± 2.5 mm in height. The samples having height more or less than 70.0 ± 2.5 mm or 60.0 ± 2.5 mm were not considered for the study and discarded.
3. Specimens compacted to 70.0 ± 2.5 mm will need to be cut down to 60.0 ± 2.5 mm before testing can commence.
4. The mixtures were prepared in batches large enough to make at least 3 specimens. Alternatively, batch was prepared large enough to just make one specimens at a time. While preparing a multi-specimen batch, the batch was divided into single-specimen quantities before placing in the oven.
5. The mixture was placed in the pan having the bottom area approximately equal to 48,400 to 129,000 mm² and depth approximately equal to 25 millimeter. The mixture was allowed to cool at 2 ± 0.5 hours at the room temperature.

6. Then the mixture was placed in an oven for curing. WMA specimens were cured at $60 \pm 3^{\circ}\text{C}$ for 16 ± 0.5 hours for curing. HMA specimens were cured at $135 \pm 3^{\circ}\text{C}$ for 4 ± 0.5 hours for curing. The pans were placed on spacers to allow air circulation under it.
7. After curing, the mixture was placed in an oven for 2 hours \pm 10 minutes at the compaction temperature $\pm 3^{\circ}\text{C}$ prior to compaction. The mixture is compacted to 7 ± 0.5 percent air voids. The optimum number of gyrations was found necessary to achieve the air voids in the range of 6.5 to 7.5 %. The void range was obtained by adjusting different number of gyrations for different products.
8. After the specimens are removed from the molds, they are stored at room temperature for 24 ± 3 hours.

Evaluating and Grouping of Compacted Specimens

After curing, the following tests and measurements of each specimen were conducted by following the methods explained before:

1. The maximum specific gravity (G_{mm}) was measured using the Rice Specific Gravity test.
2. The thickness (t) and diameter (D) was measured of each specimen.
3. The bulk specific gravity (G_{mb}) was measured in accordance with AASHTO – T 166. The volumes of the specimens were determined by subtracting the specimen weight in water from the saturated, surface-dry weight.
4. Once determined, the specimens are separated into two subsets, of at least three specimens each, so that the average air voids of the two subsets, for dry subset

specimens and wet subset specimens, are approximately equal.

5. If the determined air void is found out of range from 6.5% to 7.5%, the specimen was discarded.

Preparing Specimens for Hamburg Wheel Tracker Test

1. Specimens were grouped in pairs that had an average air void content as close to 7.0% as possible.
2. If the specimens were compacted to 70.0 ± 2.5 mm they need to be cut down to 60.0 ± 2.5 mm.
3. Using an additional mold from the Hamburg Wheel Tracking Device, 60 mm from the top was measured and a line was drawn around the specimen.
4. The specimen was then loaded and locked into a core grip that would ensure no movement occurred during sawing.



Figure A12: Concrete saw used to cut specimens



Figure A13: 70.0 mm core marked and loaded into the core grip

5. The core is then cut down to 60.0 mm using the concrete saw. The cores need to have a side shaved off so they fit together inside the Hamburg Wheel Tracker. 7.5 mm needs to be shaved off the sides of the cores. Since the cores are not perfectly level, they need to be rotated until an equal height is reached.

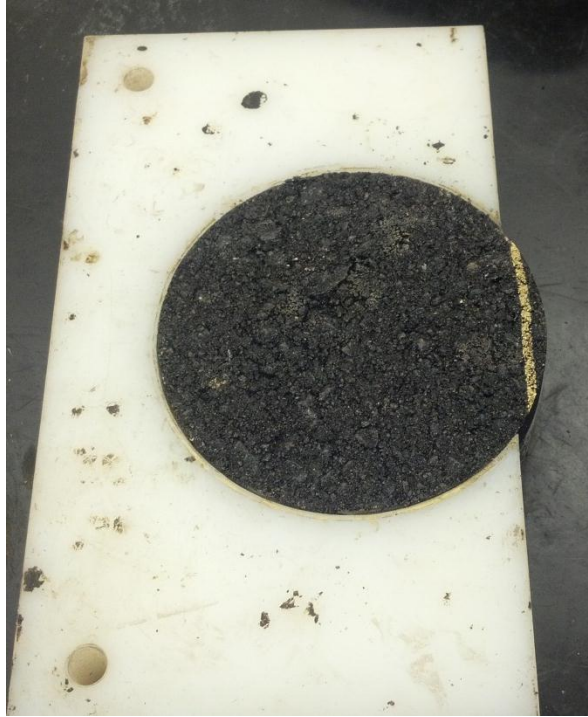

Figure A14: Marked core prepared to have 7.5 mm shaved off

6. After the cores have been cut and shaved down they are loaded and locked into the Hamburg Wheel Tracking Device.

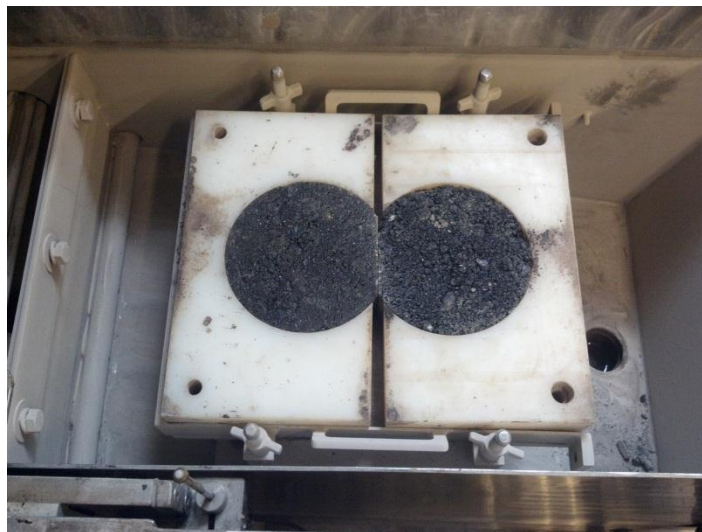

Figure A15: Cores loaded into the Hamburg Wheel Tracker

7. The test is then setup using software included with the Hamburg Wheel Tracker. The mix type, start delay, pressure and maximum impression depth are selected here. After the test setup is complete, the test can begin. The test is fully automated with the only external input being lowering the wheel after the 30 minute start delay has been reached.
8. After the test is complete, the specimens are removed from the molds and the data from the test is saved.
9. The data is analyzed by plotting the rut depth versus the number of passes to failure. The slope and intercept of the first and second steady-state portion of the curves are determined and used to calculating the stripping inflection point. The equation is as follows:

$$\text{Stripping Inflection Point (SIP)} = \frac{\text{Second Intercept} - \text{First Intercept}}{\text{First Slope} - \text{Second Slope}}$$

Equation A6: Stripping Inflection Point

APPENDIX B.
DATA OF ALL EXPERIMENTS

Gmm calculation	HMA - 5.65% (58-28)		WMA - 5.00% (58-28 + 1.5% Additive)		HMA - 5.0% (64-22)		WMA - 5.0% (64-22 + 1.0% Additive)	
	1	2	1	2	1	2	1	2
Sample								
Wt of picnometer	7335.7	7335.7	7337.7	7337.7	7332.9	7332.9	7330.9	7330.9
wt of asphalt sample	2000.1	2000.4	2000	2000	2000	2000	2000	2000
Wt of asphalt sample in picnometer	8525.6	8526.5	8530.9	8532	8525.8	8526.3	8519.3	8519.5
Theoretical Max SG	2.469	2.471	2.479	2.482	2.478	2.480	2.464	2.465
1S, 0.0040	0.0016		0.0024		0.0011		0.0004	
D2S, 0.011	0.0022		0.0034		0.0015		0.0006	
Average of Gmm	2.470		2.481		2.479		2.465	

Table B1: Gmm data and results from Rice Specific Gravity Tests

Source	Lime Stone	HMA Lab (58-28)							D2S, AASHTO T166	
		% Ac	Sample ID	Dry	Wet	SSD	G _{mb}	Avg, G _{mb}	% Absorption	Avg.Absorbtion
5.20	L1, 5.2%	4818.1	2825.5	4831.1	2.402	2.400	0.65	0.67	0.005	0.02
	L2, 5.2%	4763.2	2789.9	4776.8	2.397		0.68			
5.65	L1, 5.65%	4742.1	2776.9	4747.6	2.406	2.405	0.28	0.24	0.003	0.02
	L2, 5.65%	4748.0	2776.7	4752.0	2.404		0.20			
6.10	L1, 6.10%	4709.9	2762.2	4714.2	2.413	2.415	0.22	0.20	0.004	0.02
	L2, 6.10%	4711.1	2765.4	4714.5	2.417		0.17			
Ndes	L1, 5.0%	4780	2801.8	4789.9	2.404	2.400	0.50	0.65	0.008	0.02
	L2, 5.0%	4778.5	2800.3	4794.3	2.396		0.79			
Nmax	L1, 5.0%	4773.3	2821.8	4779	2.439	2.439	0.29	0.30	0.001	0.02
	L2, 5.0%	4773.5	2822.7	4779.5	2.439		0.31			

Table B2: Gmb data and results of HMA using PG 58-28 binder

Source	Lime Stone	HMA Lab (64-22)							D2S, AASHTO T166	
% Ac	Sample ID	Dry	Wet	SSD	G _{mb}	Avg, G _{mb}	% Absorption	Avg.Absorbtion	Measured	Spec
5.00	L1, 5.00%	4743.7	2759.8	4757.3	2.375	2.373	0.68	0.67	0.004	0.02
	L2, 5.00%	4743.5	2756.0	4756.8	2.371		0.66			
5.50	L1, 5.50%	4710.6	2738.2	4718.3	2.379	2.378	0.39	0.37	0.002	0.02
	L2, 5.50%	4710.6	2735.9	4717.6	2.377		0.35			
6.00	L1, 6.00%	4674.4	2715.4	4677.8	2.382	2.381	0.17	0.16	0.002	0.02
	L2, 6.00%	4675.3	2713.9	4678.3	2.380		0.15			
Ndes	L1, 5.0%	4743.2	2757.8	4757.9	2.371	2.371	0.73	0.735	XXX	0.02
Nmax	L1, 5.0%	4744.1	2770.2	4752.1	2.394	2.394	0.40	0.807	XXX	0.02

Table B3: Gmb data and results of HMA using PG 64-22 binder

% Ac	Sample ID	A	B	C	G _{mb}	G _{mm}	% Va
5.0	Lab HMA 1	1199.4	693.4	1203.0	2.35	2.494	5.63
	Lab HMA 2	1100.0	611.1	1112.4	2.19	2.494	12.02
	Lab HMA 3	1000.9	543.7	1022.4	2.09	2.494	16.16

Table B4: TSR volumetric results of lab mixed HMA using PG 58-28

% Ac	Sample ID	A	B	C	G _{mb}	G _{mm}	% Va
5.0	Lab WMA 1	1197.9	692.7	1200.9	2.36	2.481	4.99
	Lab WMA 2	1152.3	657.6	1162.7	2.28	2.481	8.05
	Lab WMA 3	1103.1	616.8	1126.2	2.17	2.481	12.72

Table B5: TSR volumetric results of lab mixed WMA using PG 58-28 modified with 1.5% additive

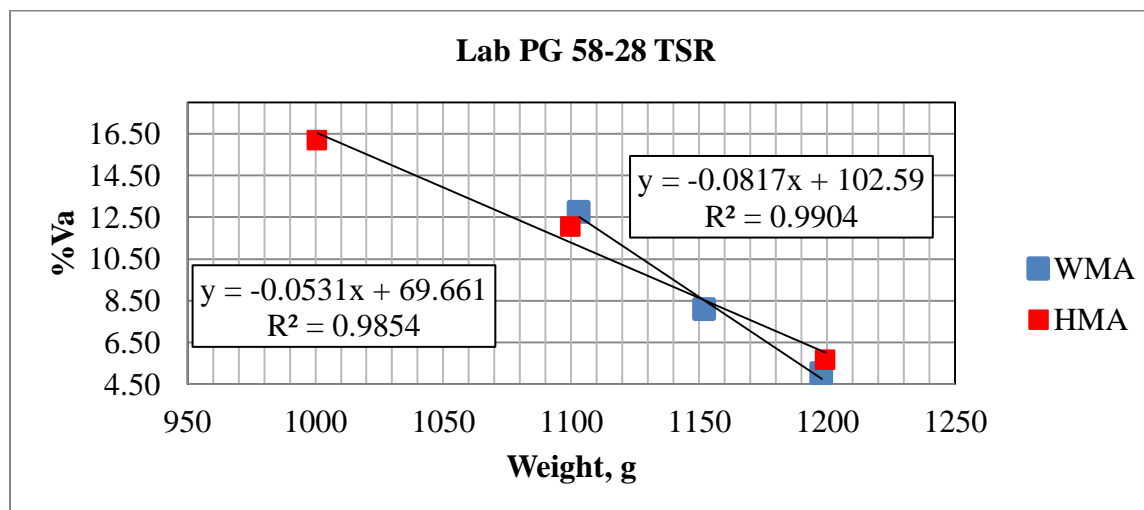

Figure B1: Visualization of lab mixed TSR volumetric data

% Ac	Sample ID	A	B	C	G _{mb}	G _{mm}	% Va
5.5	Field HMA 1	1199.2	698.3	1199.4	2.393	2.467	2.99
	Field HMA 2	1097.6	611.7	1108.2	2.211	2.467	10.39
	Field HMA 3	994.1	539.3	1018.6	2.074	2.467	15.93

Table B6: TSR volumetric results of field mixed HMA

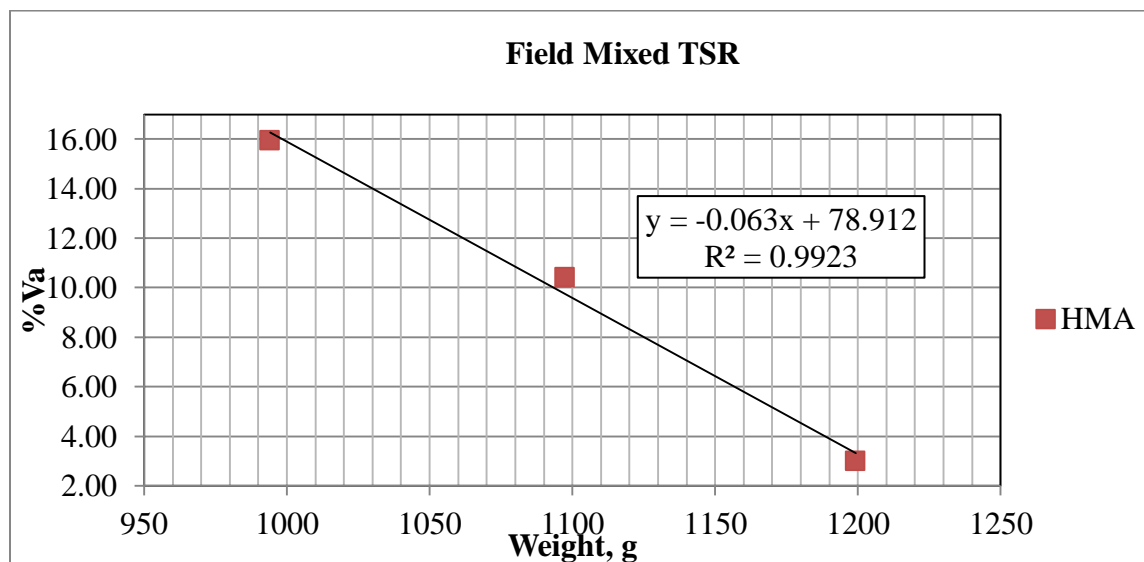

Figure B2: Visualization of field mixed TSR volumetric data

% Ac	Sample ID	A	C	B	G _{mb}	G _{mm}	% Va
5.00	Lab HMA 1	2802.1	1602.7	2812.8	2.316	2.494	7.15
	Lab HMA 2	2699.2	1508.2	2713.6	2.239	2.494	10.21
	Lab HMA 3	2600.3	1428.8	2629.7	2.165	2.494	13.18

Table B7: Hamburg volumetric results of lab mixed HMA using PG 58-28

% Ac	Sample ID	A	C	B	G _{mb}	G _{mm}	% Va
5.00	Lab WMA 1	2801	1617.5	2820	2.329	2.481	6.11
	Lab WMA 2	2701.2	1547.2	2743.9	2.257	2.481	9.02
	Lab WMA 3	2599.6	1481.3	2661.3	2.203	2.481	11.20

Table B8: Hamburg volumetric results of lab mixed WMA using PG 58-28 modified with 1.5% additive

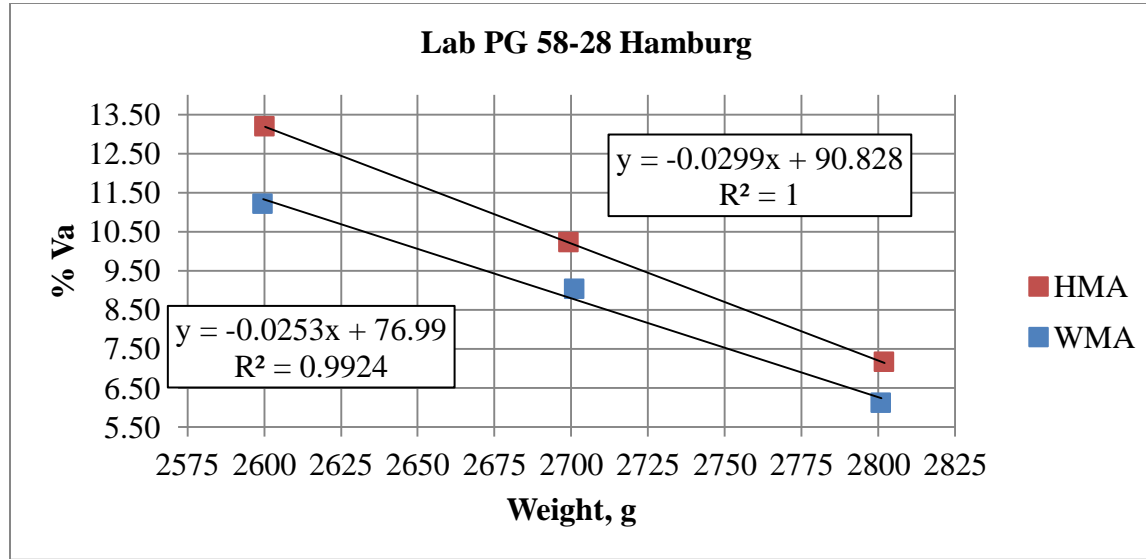

Figure B3: Visualization of lab mixed PG 58-28 Hamburg volumetric data

% Ac	Sample ID	A	C	B	G _{mb}	G _{mm}	% Va
5.00	Lab HMA 1	2201.5	1253.6	2257.6	2.193	2.479	11.55
	Lab HMA 2	2301.4	1318.7	2328.6	2.279	2.479	8.07
	Lab HMA 3	2400.8	1386.6	2407.8	2.351	2.479	5.16

Table B9: Hamburg volumetric results of lab mixed HMA using PG 64-22

% Ac	Sample ID	A	C	B	G _{mb}	G _{mm}	% Va
5.00	Lab WMA 1	2200.9	1236.2	2249.7	2.172	2.465	11.90
	Lab WMA 2	2301.6	1302.6	2327.5	2.246	2.465	8.90
	Lab WMA 3	2396.2	1375.6	2400.9	2.337	2.465	5.19

Table B10: Hamburg volumetric results of lab mixed WMA using PG 64-22 modified with 1.0% additive

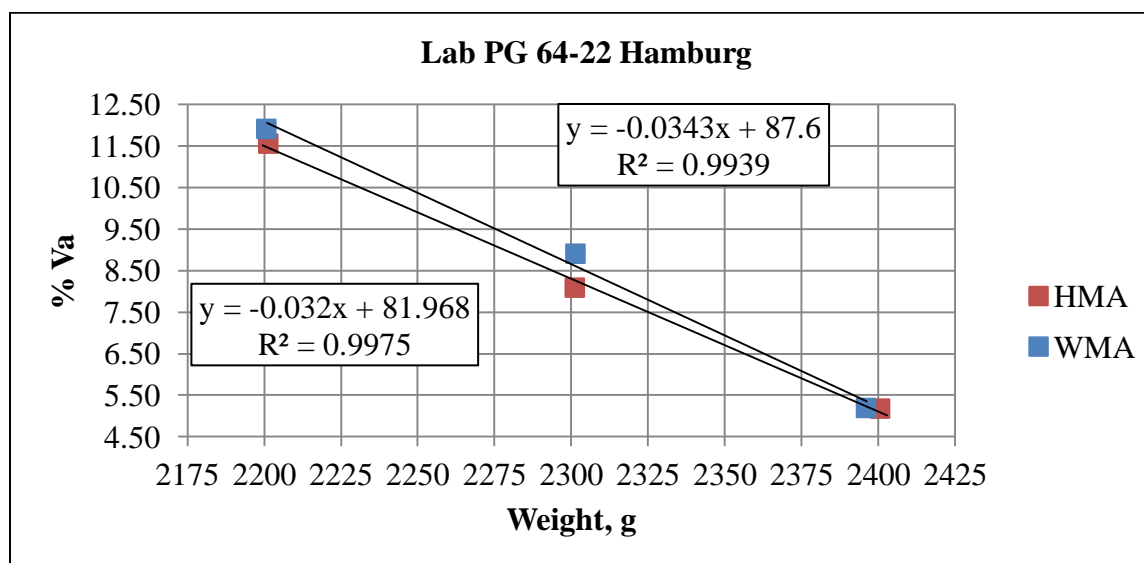

Figure B4: Visualization of lab mixed PG 64-22 Hamburg volumetric data

% Ac	Sample ID	A	C	B	G _{mb}	G _{mm}	% Va
5.50	Field HMA 1	2774.8	1589.8	2776.6	2.338	2.476	5.57
	Field HMA 2	2684.2	1517.9	2703	2.265	2.476	8.52

Table B11: Hamburg volumetric results of field mixed HMA

% Ac	Sample ID	A	C	B	G _{mb}	G _{mm}	% Va
5.50	Field WMA 1	2777.6	1584.4	2778.8	2.326	2.461	5.51
	Field WMA 2	2683.1	1524.5	2703.6	2.276	2.461	7.54

Table B12: Hamburg volumetric results of field mixed WMA

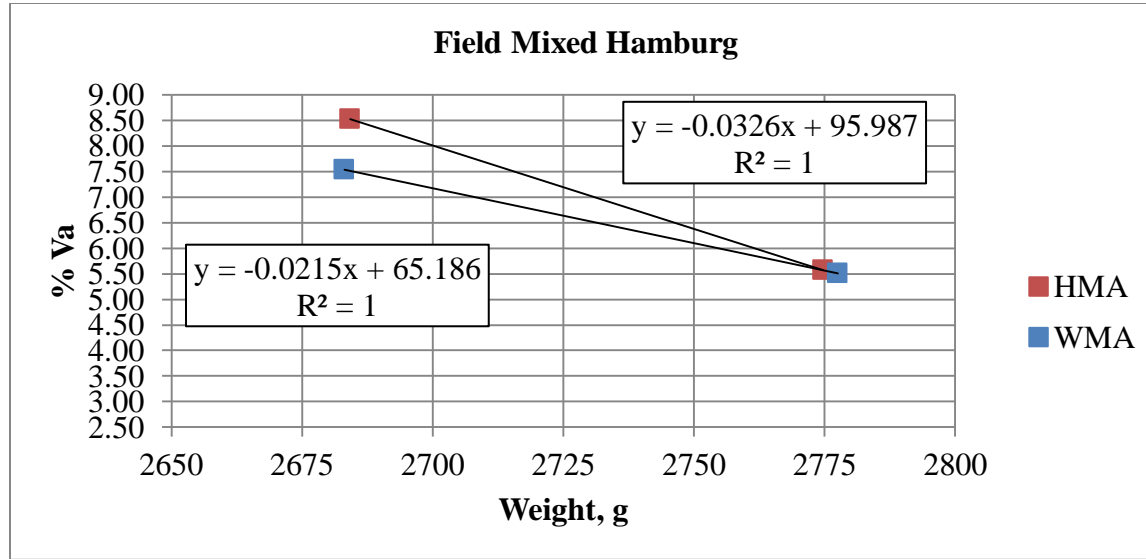

Figure B5: Visualization of field mixed Hamburg volumetric data

% Ac	Sample ID	A	C	B	G _{mb}	G _{mm}	% Va
5.50	Field HMA 1	2198	1239.4	2263.8	2.146	2.476	13.34
	Field HMA 2	2299	1288.2	2326.4	2.214	2.476	10.57
	Field HMA 3	2398.5	1360	2404.6	2.296	2.476	7.27

Table B13: Hamburg volumetric results of aged field mixed HMA

% Ac	Sample ID	A	C	B	G _{mb}	G _{mm}	% Va
5.50	Field WMA 1	2297.4	1295.7	2323.6	2.235	2.461	9.18
	Field WMA 2	2399.8	1364.5	2403.5	2.310	2.461	6.15
	Field WMA 3	2497.9	1449.5	2498.8	2.381	2.461	3.27

Table B14: Hamburg volumetric results of aged field mixed WMA

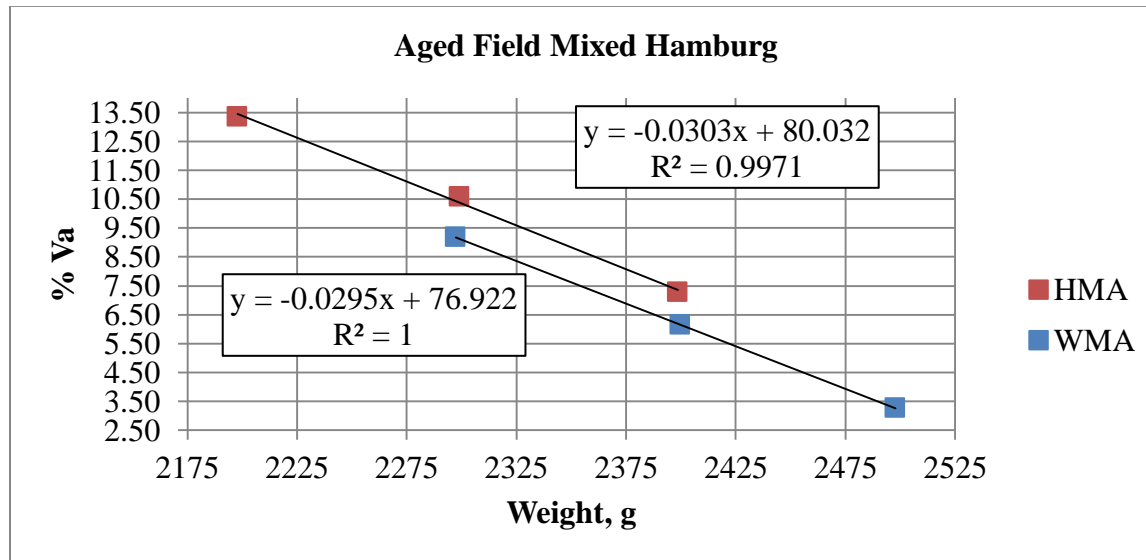

Figure B6: Visualization of aged field mixed Hamburg volumetric data

Hamburg Gmbs, HMA PG 58-28				
Specimen	Dry	Wet	SSD	Gmb
LH1	2803.6	1590.3	2793.6	2.330
LH2	2803.2	1591.5	2794.6	2.330
LH3	2804.5	1589.9	2792.5	2.332
LH4	2801.3	1589.5	2793.3	2.327
LH5	2806.3	1590.4	2797.9	2.324
LH6	2803.5	1591.8	2794.5	2.331

Table B15: Gmbs for lab mixed Hamburg HMA specimens using PG 58-28 binder

Hamburg Gmbs, WMA PG 58-28				
Specimen	Dry	Wet	SSD	Gmb
LW1	2766.8	1583.2	2778.4	2.315
LW2	2766.4	1582.6	2775.5	2.319
LW3	2767.5	1584.0	2777.9	2.318
LW4	2768.3	1581.3	2775.6	2.318
LW5	2764.7	1583.3	2778.1	2.314
LW6	2765.3	1584.3	2777.8	2.317

Table B16: Gmbs for lab mixed Hamburg WMA specimens using PG 58-28 binder

Hamburg Gmbs, HMA PG 64-22				
Specimen	Dry	Wet	SSD	Gmb
LH1	2349.4	1345.8	2365.6	2.303
LH2	2348.6	1346.6	2366.2	2.304
LH3	2351.8	1349.8	2368.1	2.309
LH4	2349.7	1347.1	2367.9	2.302
LH5	2349.8	1348.5	2364.7	2.312
LH6	2351.1	1346.9	2369.8	2.298

Table B17: Gmbs for lab mixed Hamburg HMA specimens using PG 64-22 binder

Hamburg Gmbs, WMA PG 64-22				
Specimen	Dry	Wet	SSD	Gmb
LW1	2347.8	1335.5	2363.4	2.284
LW2	2349.5	1340.5	2366.1	2.291
LW3	2350.7	1339.5	2366.3	2.289
LW4	2348.7	1340.5	2367.4	2.287
LW5	2349.2	1345.1	2370.0	2.292
LW6	2349.6	1343.5	1371.3	2.286

Table B18: Gmbs for lab mixed Hamburg WMA specimens using PG 64-22 binder

Hamburg Gmbs, Field HMA				
Specimen	Dry	Wet	SSD	Gmb
FH1	2680.7	1532.9	2697.7	2.301
FH2	2680.3	1532.6	2698.4	2.299
FH3	2777.3	1570.2	2781.6	2.293
FH4	2780.0	1578.2	2784.7	2.304
FH5	2725.3	1545.7	2733.8	2.294
FH6	1724.3	1553.6	2741.2	2.294

Table B19: Gmbs for field mixed Hamburg HMA specimens

Hamburg Gmbs, Field WMA				
Specimen	Dry	Wet	SSD	Gmb
FW1	2779.2	1570.2	2780.9	2.295
FW2	2770.5	1568.5	2772.4	2.301
FW3	2773.4	1566.9	2778.9	2.288
FW4	2771.6	1570.5	2783.3	2.285
FW5	2767.4	1567.2	2776.9	2.287
FW6	2772.0	1571.2	2778.2	2.297

Table B20: Gmbs for field mixed Hamburg WMA specimens

Hamburg Gmbs, Aged Field HMA				
Specimen	Dry	Wet	SSD	Gmb
FHA1	2407.5	1370.7	2413.3	2.309
FHA2	2394.9	1361.3	2402.6	2.299
FHA3	2407.9	1369.3	2412.6	2.308
FHA4	2406.7	1366.9	2410.3	2.306
FHA5	2403.9	1367.3	2407.6	2.311
FHA6	2395.5	1360.3	2402.0	2.299

Table B21: Gmbs for aged field mixed Hamburg HMA specimens

Hamburg Gmbs, Aged Field WMA				
Specimen	Dry	Wet	SSD	Gmb
FWA1	2368.9	1340.4	2379.4	2.279
FWA2	2371.6	1342.2	2380	2.285
FWA3	2369.4	1343.7	2380.5	2.285
FWA4	2368.3	1341.2	2379.8	2.280
FWA5	2363.7	1342.1	2374.1	2.290
FWA6	2368.7	1342.9	2380.1	2.283

Table B22: Gmbs for aged field mixed Hamburg WMA specimens

APPENDIX C.

GSB INFO FROM RIVER PRODUCTS COMPANY

THE RIVER PRODUCTS COMPANY	APPENDIX A		
AGGREGATE SPECIFIC GRAVITY (I.M. 380)			
FOR COMBINED OR INDIVIDUAL SOURCES			
PROJECT NO.:	DATE: 01/16/12		
PROJECT LOCATION:			
CONTRACTOR:	COUNTY: JOHNSON		
MIX:	BEDS: (21-22) SIZE: 3/8" POROUS BACKFILL		
AGGREGATE SOURCE:	RPC - CONKLIN		
TESTED BY: DOUG	LAB NO.: 1411-001-2012		
IDENTIFICATION - LAB NO.: A52004			
01	PYCNO METER NO.	1	
02	WEIGHT OF CONTAINER & SAMPLE	2881.6	
03	WEIGHT OF CONTAINER	1616.9	
04	SAMPLE WEIGHT (2 - 3) W	1264.7	
05	PYCNO METER & WATER @ TEMP. W1	5994.5	
06	TOTAL WEIGHT (4 + 5) W+W1	7259.2	
07	PYC. & SAMPLE & WATER W2	6793.3	
08	DISPLACED WATER (6 - 7)	465.9	
09	TEST TEMPERATURE OF WATER DEG. F	76	
10	R MULTIPLIER (CHART)	1.0001	AVERAGE
11	VACUUM APPARENT { (W) (R) / 8 } Gsa	2.715	2.715
		+ #8	- #8
12	WEIGHT OF SSD MATERIAL	1272.6	
13	WEIGHT OF DRY MATERIAL	1258.2	
14	WEIGHT OF ABSORBED WATER (12 - 13)	14.4	
15	WEIGHT ABSORBED (LINE 14 (+ #8 + - #8))	14.4	
16	WEIGHT OF DRY MTL. (LINE 13 (+ #8 + - #8))	1258.2	TOTAL
17	% ABSORPTION (100) (15) / (16)	1.144	1.14
		0.0114	
18	ABSORPTION = % ABSORPTION / 100	0.0114	
19	1 + (ABS) (Gsa) (1 + (18) (11))	1.031	
20	Gsb, LINE 11 / LINE 19	2.633	2.633

Figure C1: Gsb calculation from River Products Company

APPENDIX D.
FIELD DATA FROM L.L. PELLING

Form 955 ver. 6.5r

Iowa Department of Transportation
Highway Division-Office of Materials
Proportion & Production Limits For Aggregates

County: Johnson Project No.: City of Iowa City Date: 08/08/11
Project Location: Capitol Street Mix Design No.: ABD8-6008R2
Contract Mix Tonnage: Course: Surface Mix Size (in.): 1/2
Contractor: L.L.Pelling Co. Mix Type: HMA 1M Design Life ESAL's

Material	Ident #	% in Mix	Producer & Location	Type (A or B)	Friction Type	Beds	Gsb	%Abs
Sand	A52508	25.0%	S & G Materials		4	Williams	2.634	0.47
TA M.Sand	A52006	21.0%	River Products Co.; Klein	A	5	21-22	2.630	1.12
3/8" A	A52004	30.0%	RPC-Conklin	A	4	3-10	2.642	1.01
5/8" A	A52006	14.0%	River Products Co.; Klein	A	5	21-22	2.640	1.08
RAP		10.0%	ABD11-0070			5.16	2.597	1.50

Type and Source of Asphalt Binder: PG64-22 Flint Hills @ Dav

Individual Aggregates Sieve Analysis - % Passing (Target)											
Material	1"	3/4"	1/2"	3/8"	#4	#8	#16	#30	#50	#100	#200
Sand	100	100	100	100	95	90	79	53	16	2.0	1.0
TA M.Sand	100	100	100	100	99	76	37	13	4.1	2.3	2.0
3/8" A	100	100	100	97	45	16	12	10	9.0	7.5	6.0
5/8" A	100	100	69	41	5.5	1.2	1.1	1.0	1.0	1.0	1.0
RAP	100	100	88	80	61	46	36	27	17	12	10

Preliminary Job Mix Formula Target Gradation

Upper Tolerance	100	100	100	96	72	53		26			5.6
Comb Grading	100	100	95	89	65	48	35	22	9.4	4.5	3.6
Lower Tolerance	100	100	88	82	58	43		18			1.6
S.A.sq. m/kg	Total	4.59		+0.41	0.27	0.39	0.57	0.63	0.57	0.56	1.18

Production Limits for Aggregates Approved by the Contractor & Producer.

Sieve Size in.	25.0% of mix Sand		21.0% of mix TA M.Sand		30.0% of mix 3/8" A		14.0% of mix 5/8" A		10.0% of mix RAP	
	Min	Max	Min	Max	Min	Max	Min	Max	Min	Max
1"	100.0	100.0	100.0	100.0	100.0	100.0	100.0	100.0		
3/4"	100.0	100.0	100.0	100.0	100.0	100.0	100.0	100.0		
1/2"	100.0	100.0	100.0	100.0	100.0	100.0	62.0	76.0		
3/8"	100.0	100.0	100.0	100.0	90.0	100.0	34.0	48.0		
#4	88.0	100.0	95.0	100.0	35.0	49.0	0.0	12.0		
#8	85.0	95.0	71.0	81.0	10.0	20.0	0.0	6.0		
#30	49.0	57.0	16.0	24.0	5.0	13.0	0.0	5.0		
#200	0.0	3.0	0.5	4.5	3.5	7.5	0.0	3.0		

Comments:

Copies to: L.L.Pelling Co. Roger Boulet Area Inspectors

The above target gradations and production limits have been discussed with and agreed to by an authorized representative of the aggregate producer.

Signed: _____
Producer

Signed: *Henry A. Pelling*
Contractor

3 0

8994-626-4608

Aug 16 2011 2:53PM L.L.Pelling Co. Lab

Figure D1: Aggregate gradation

Form 956 ver. 6.5r

Iowa Department of Transportation

Highway Division - Office of Materials
HMA Gyratory Mix Design

County : Johnson Project : City of Iowa City Mix No. : ABD8-6008R2
 Mix Size (In.): 1/2 Type A Contractor : L.L.Pelling Co. Contract No. :
 Mix Type: HMA 1M None Design Life ESAL's : Date Reported : 08/08/11
 Intended Use : Surface Project Location : Capitol Street

Aggregate	% in Mix	Source ID	Source Location	Beds	Gsb	%Abs	FAA
Sand	25.0%	A52508	S & G Materials	Williams	2.634	0.47	41.3
TA M.Sand	21.0%	A52006	River Products Co.; Klein	21-22	2.630	1.12	47.1
3/8" A	30.0%	A52004	RPC-Conklin	3-10	2.642	1.01	47.1
5/8" A	14.0%	A52006	River Products Co.; Klein	21-22	2.640	1.08	47.1
RAP	10.0%		ABD11-0070	5.16	2.597	1.50	41.0

Job Mix Formula - Combined Gradation (Sieve Size in.)

1"	3/4"	1/2"	3/8"	#4	#8	#16	#30	#50	#100	#200
Upper Tolerance										
100	100	100	96	72	53		26			5.6
100	100	95	89	65	48	35	22	9.4	4.5	3.6
100	100	88	82	58	43		18			1.6
Lower Tolerance										

Asphalt Binder Source and Grade: Flint Hills @ Dav PG64-22

	Gyratory Data				Number of Gyration
	5.00	5.15	5.50	6.00	
% Asphalt Binder	5.00	5.15	5.50	6.00	N-Initial
Corrected Gmb @ N-Des.	2.351	2.349	2.357	2.368	7.
Max. Sp.Gr. (Gmm)	2.474	2.464	2.455	2.442	N-Design
% Gmm @ N- Initial	89.1	89.3	89.9	90.7	76
%Gmm @ N-Max	95.9	96.1	96.9	97.9	N-Max
% Air Voids	5.0	4.7	4.0	3.0	117
% VMA	15.2	15.4	15.4	15.5	Gsb for Angularity
% VFA	67.2	69.6	74.0	80.4	Method A
Film Thickness	9.85	10.36	10.99	11.92	2.633
Filler Bit. Ratio	0.80	0.76	0.72	0.66	Pba / %Abs Ratio
Gsb	2.633	2.633	2.633	2.633	0.52
Gse	2.667	2.661	2.666	2.671	Slope of Compaction
Pbc	4.52	4.75	5.05	5.47	Curve
Pba	0.50	0.42	0.50	0.56	17.5
% New Asphalt Binder	90.1	90.4	91.1	91.9	Mix Gmm Linearity
Asphalt Binder Sp.Gr. @ 25c	1.043	1.043	1.043	1.043	Good
% Water Abs	0.96	0.96	0.96	0.96	Pb Range Check
S.A. m ² / Kg.	4.59	4.59	4.59	4.59	1.00
% + 4 Type 4 Agg. Or Better	50.7	50.7	50.7	50.7	Specification Check
% + 4 Type 2 or 3 Agg.	0.0	0.0	0.0	0.0	Comply
Angularity-method A	42	42	42	42	TSR Check
% Flat & Elongated	0.5	0.5	0.5	0.5	
Sand Equivalent	86	86	86	86	

Disposition : An asphalt content of 5.5% is recommended to start this project.
 Data shown in 5.50% column is interpolated from test data.
 The % ADD AC to start project is 5.0%
 Comments : 5.2% total binder to start

Copies to : L.L.Pelling Co. Roger Boulet Area Inspectors

Mix Designer & Cert.# : Gary Netser EC125 Signed : [Signature]

Aug 16 2011 2:53PM L.L.Pelling Co. Lab

Figure D2: Mixture design completed by L.L. Pelling

800241 - 1008 ver. 3.5

Project No.: I.C. Streets
 Contract ID: _____
 Mix Design No.: ABD8-6008R2

Contractor: L.L. Pelling
 County: Johnson
 Recycle Source: I-80 shoulders

JMF VMA: 15.7
 Size: 1/2"
 Mix Type: 1M No Friction

Report No.: 4
 Lab Voids Target: 4.0
 Design Gyration: 76

Hot Box I.D. No.:	Su8-16a				Time	7:00	9:00	11:00	1:00	3:00	5:00	7:00	
Date Sampled:	08/16/11				Air Temp. °F								
Gradation ID:	Specs	Su8-16a			Binder Temp. °F								
1 in. (25mm) Sieve	100	100			Mix Temp. °F								
3/4 in. (19mm) Sieve	100	100			Mat Temp. °F								
1/2 in. (12.5mm) Sieve	88-100(95)	96			From Station	To Station	Lane	Placement And Density Record		Date Placed:	08/16/11		
3/8 in. (9.5mm) Sieve	83-97(90)	89						Course Placed:		Date Tested:	08/17/11		
* #4 (4.75mm) Sieve	59-73(66)	69						Intended Lift Thickness:		2			
* Moving Average								Tested By:		Ryan Young			
* #8 (2.36mm) Sieve	45-55(50)	49			Core No.:	1	2	3	4	5	6	7	
* Moving Average					Station								
#16 (1.18mm) Sieve		36			CL Reference								
* #30 (600um) Sieve	21-29(25)	25			W1 Dry	714.4	819.8	752.4	660.3	585.2	703.5	629.5	
* Moving Average					W2 in H20	389.1	468.0	418.3	366.8	323.6	391.2	343.4	
#50 (300um) Sieve		11			W3 Wet	715.6	820.1	753.1	660.9	586.0	704.1	630.2	
#100 (150um) Sieve		5.1			Difference	326.5	352.1	334.8	294.1	262.4	312.9	286.8	
* #200 (75um) Sieve	1.8-5.8(3.8)	4.1			Field Density	2.188	2.328	2.247	2.245	2.230	2.248	2.195	
* Moving Average					% Density	92.594	98.519	95.091	95.006	94.372	95.133	92.890	
Compliance (Y/N)		y			% Voids	11.1	5.4	8.7	8.8	9.4	8.7	10.8	
Intended Added, % Binder	4.60		% Binder from RAP		Thickness (in.)	1.6	1.75	1.7	1.5	1.4	1.6	1.45	
Actual Added, % Binder	4.60		11.01%		Gmb (Lot Avg.):	2.363		Avg. Field Density:		2.240			
Intended Total, % Binder	5.20		Actual % RAP		Gmm (Lot Avg.):	2.461		Avg. % Density:		94.801			
Actual Total, % Binder	4.90-5.50	5.17	10.48%		Pa (Lot Avg.):	4.0		Avg. % Field Voids:		9.0			
Gmb:		2.363			Target % RAP:	10.0		Specified % Density:		94			
Gmm:		2.461											
Pa:		4.0			Q.I. =	2.240 - (0.94 x 2.363) = 0.41							
Moving Average	3.5-5.0					0.046							
Time		8:30 a			Low Outlier:	1.13		High Outlier:		1.91			
Station						New Q.I. = 0.18							
Side					Film Thickness (FT):	9.7		VMA:		15		D.O.T. Results Used:	
Sample Tons		97.00				8.0-16.0				14.7-16.7			
Sublot Tons		331.46			Remarks:	Added Lead Cap to mix to create a warm mix.							
Tons to Date		682.73				35.02 T of patch base (mix design 3/4" ABD8-6008A) laid on Prentiss St							
Fines / Bitumen Ratio	0.6-1.4	0.84											

Gsb: 2.637 Gb: 1.0430 Effective % Binder (Pbe): 4.88
 Tons of Mix for Pay: 331.46 Tons of Binder for Pay: 17.14

Mix Change Information: _____

Distribution: _____ Central Materials _____ Dist. Materials _____ Proj. Engineer _____ Contractor _____ Plant _____

Certified Tech: Dave McDowell EC898 Cert. No. _____
 Certified Tech: Megan Finnegan EC740 Cert. No. _____

Figure D3: Core info from Capitol Street gathered by L.L. Pelling

800241 - 1009 ver. 3.5

Project No.: I.C. Streets
 Contract ID: _____
 Mix Design No.: ABD8-6008R2

DAILY HMA PLANT REPORT
 Contractor: L.L.Pelling
 County: Johnson
 Recycle Source: I-80 shoulders

JMF VMA: 15.7
 Size: 1/2"
 Mix Type: 1M No Friction

Report No.: 5
 Lab Voids Target: 4.0
 Design Gyration: 76

Hot Box I.D. No.:	Sub-17a			Time	7:00	9:00	11:00	1:00	3:00	5:00	7:00
Date Sampled:	08/17/11			Air Temp. °F							
Gradation ID:	Sub-17a			Binder Temp. °F							
1 in. (25mm) Sieve	100	100		Mix Temp. °F							
3/4 in. (19mm) Sieve	100	100		Mat Temp. °F							
1/2 in. (12.5mm) Sieve	88-100(95)	95		From Station	To Station	Lane	Placement And Density Record		Date Placed:	08/17/11	
3/8 in. (9.5mm) Sieve	83-97(90)	88					Course Placed:		Date Tested:	08/18/11	
* #4 (4.75mm) Sieve	59-73(66)	68					Intended Lift Thickness:		2		
* Moving Average							Tested By:		Ryan Young		
* #8 (2.36mm) Sieve	45-55(50)	51		Core No.:	1	2	3	4	5	6	7
* Moving Average				Station							
#16 (1.18mm) Sieve		38		CL Reference							
* #30 (600um) Sieve	21-29(25)	27		W1 Dry	824.3	759.7	726.7	721.3	740.6	629.9	672.8
* Moving Average				W2 In H2O	467.8	430.3	415.5	404.0	419.8	353.6	382.5
#50 (300um) Sieve		11		W3 Wet	824.6	760.2	727.0	721.7	740.9	630.1	673.0
#100 (150um) Sieve		5.3		Difference	356.8	329.9	311.5	317.7	321.1	276.5	290.5
* #200 (75um) Sieve	1.8-5.3(3.8)	4.2		Field Density	2.310	2.303	2.333	2.270	2.306	2.278	2.316
* Moving Average				% Density	97.633	97.337	98.605	95.943	97.464	96.281	97.887
Compliance (Y/N)	y			% Voids	6.7	7.0	5.8	8.3	6.9	8.0	6.5
Intended Added, % Binder	4.60		% Binder from RAP	11.01%							
Actual Added, % Binder		4.60	Actual % RAP	10.48%							
Intended Total, % Binder	5.20										
Actual Total, % Binder	4.90-5.50	5.17									
Gmb:		2.366		Gmb (Lot Avg.):	2.366				Avg. Field Density:	2.302	
Gmm:		2.476		Gmm (Lot Avg.):	2.476				Avg. % Density:	97.307	
Pa:		4.4		Pa (Lot Avg.):	4.4				Avg. % Field Voids:	7.0	
Moving Average	3.5-5.0			Target % RAP:	10.0				Specified % Density:	95	
Time				Q.I. =	2.302	-	(0.95	x	2.366) =	2.47
Station									0.022		
Side				Low Outlier:					High Outlier:		New Q.I. =
Sample Tons		100.00		Film Thickness (FT):	8.9	VMA:	14.9	D.O.T. Results Used:			
Sublot Tons		286.39			8.0-15.0		14.7-16.7				
Tons to Date		989.12		Remarks:	10.01 T of patch laid on Nevada and Miami (mix design 3/4" ABD8-6008A)						
Fines / Bitumen Ratio	0.6-1.4	0.91									

Gsb: 2.637 Gb: 1.0430 Effective % Binder (Pbe): 4.62
 Tons of Mix for Pay: 286.39 Tons of Binder for Pay: 14.80

Mix Change Information: _____
 Distribution: _____ Central Materials _____ Dist. Materials _____ Proj. Engineer _____ Contractor _____ Plant

Certified Tech: Dave McDowell EC898 Cert. No.
 Certified Tech: Megan Finnegan EC740 Cert. No.

Figure D4: Core info from Miami Drive gathered by L.L. Pelling

REFERENCES

1. D'Angelop, J., Harm, E., Barloszek, J., Baumgardner, G., Carrigan, M., Cowsert, J. (2008) Warm-Mix Asphalt: European Practice. Alexandria, VA : Federal Highway Administration. FHWA-PL-08-007.
2. Prowell, B. D., and Hurley, G. C. (2007). "War-Mix Asphalt: Best Practices." Quality Improvement Series 125, National Asphalt Pavement Association. NAPA: Lanham, MD.
3. Sasol Wax North America Corporation (November, 2011). "Sasobit Asphalt Technology," <http://www.sasolwax.us.com/index.html>
4. MeadWestvaco Asphalt Innovations (November, 2011). "Evotherm Warm Mix," <http://www.meadwestvaco.com/Products/MWV002106>
5. Bonaquist, R., Advanced Asphalt Technologies, LLC, (2008). "Mix Design Practices for Warm Mix." Interim Report NCHRP 9-43, National Cooperative Highway Research Program, Transportation Research Board.
6. PQ Corporation (November, 2011) "Advera® WMA Warm Mix Asphalt" <http://www.pqcorp.com/Literature/adverawmapamphlet.pdf>
7. Ala R. Abbas, Ayman Ali. (2011). "Mechanical Properties of Warm Mix Asphalt Prepared Using Foamed Asphalt Binders." Report No. FHWA/OH-2011/6. Ohio Department of Transportation.
8. U.S. Department of Transportation: Federal Highway Administration (November, 2011) "Asphalt Pavement Technology: Equipment Hamburg Wheel Tracking Device" <http://www.fhwa.dot.gov/pavement/asphalt/labs/mixtures/hamburg.cfm>
9. Aschenbrener, T., Terrel, R., Zamora, R. (January, 1994) "Comparison of the Hamburg Wheel-Tracking Device and the Environmental Conditioning System to Pavements of Known Stripping Performance" CDOT-DTD-R-94-1 Colorado Department of Transportation, Denver, Colorado.
10. Rand, D. (2006) "Hamburg Wheel Test" Texas Department of Transportation Technical Advisory Construction and Bridge Division, Texas Department of Transportation, TX
11. Hines, M. (1991) "The Hamburg Wheel-Tracking Device" Proceedings of the Twenty-Eighth Paving and Transportation Conference. Civil Engineering Department, The University of New Mexico, Albuquerque, NM.
12. U.S. Department of Transportation: Federal Highway Administration (November, 2011) "Asphalt Pavement Technology: Equipment Hamburg Wheel Tracking Device" <http://www.fhwa.dot.gov/pavement/asphalt/labs/mixtures/hamburg.cfm>

13. Izzo, R. P., Tahmoressi, M. (1999) Use of the Hamburg Wheel-Tracking Device for Evaluating Moisture Susceptibility of Hot-Mix Asphalt: Transportation Research Board Paper No. 99-0955
14. Hall, K., Williams, S. (1998) Acquisition and Evaluation of Hamburg Wheel-Tracking Device. MBTC FR-1044
15. Bonaquist, R. (2011) Mix Design Practices for Warm Mix Asphalt. NCHRP Report 691: Project 09-43.
16. Roberts, F., Roberts, V., Kandhal, Kennedy, D., Brown, K. (1996) Hot Mix Asphalt Materials, Mixture Design and Construction, 2nd ed. Lanham, MD, Napa Research and Education Foundation.